

# SPANISH TRAIL SPECIFIC PLAN

DECEMBER 10, 2013



# Table of Contents:

## Section 1: Project Background

- 1.0 Introduction and Background
- 1.1 Context and Conditions
- 1.2 Land Use Plan
- 1.3 Circulation
- 1.4 Open Space, Cultural and Historical Resources

## Section 2: Site Utilities

- 2.1 Sanitary Sewer
- 2.2 Storm Sewer
- 2.3 Water
- 2.4 Gas
- 2.5 Electric
- 2.6 Telephone/Cable
- 2.7 Site Grading/Drainage

## Site Plan Exhibits

- 3.1 Site Plan
- 3.2 Parcel Type Plan
- 3.3 Truck Access Plan
- 3.4 Pedestrian Access Plan
- 3.5 Fire Hydrant Access Plan
- 3.6 Transit Stop and Bicycle Path Plan
- 3.7 Buildable Area Plan
- 3.8 Monument Sign Plan





## **Intent and statement of Philosophy**

The Shoppes at Spanish Trail Design Guidelines have been prepared to guide the developer and/or tenant, as well as the building architect, landscape architect, civil engineer, and other consultants in expediting the design, approval process and construction of the development.

It is the intent that proposed development meets the highest possible standards for site planning, building design, construction, and all other aspects which affect the quality of the Shoppes development to create an architecturally compatible and complementary project. Purchasers/Lessor should respond to and develop in accordance with the unique theme of the Shoppes architecture and landscaped surroundings. Malcolm Riley and Associates recognizes that each Purchaser/Lessor desires to maintain some degree of individual identity. This may be achieved through conscientious planning by the purchaser/lessor, coordination with City of Barstow, and adherence to the criteria presented herein. The resulting totally integrated development will benefit all concerned.

To assure conformity with these principles, City of Barstow will require that the standards set forth herein be adhered to in its review process prior to the commencement of construction. This review process is set forth in Section 2. The design and construction standards are outlined in Section 3.

These Design Guidelines have been reviewed by the City of Barstow Planning Commission (NOT YET). By this their approval, the Planning Commission empowers the City Planner to review development plans submitted by the out-parcel and tenant developed building owners and developers, and if such plans are in basic conformance with this section, then the City Planner can approve such plans. The City Planner shall reasonably interpret this document in the context of the use and special circumstances that may arise, in the development of this site.

## **City of Barstow Authority and Liability**

City of Barstow's approval of the Purchaser's/Lessor's submittals is for compliance with the criteria established in this Handbook only. By reviewing these drawings, the City of Barstow and its agents assume no responsibility for code compliance, dimensional accuracy, or completeness of the drawings for construction purposes. Approval of drawings by City of Barstow is not to supersede the approval by a local reviewing party having jurisdiction.

The City of Barstow will be the interpreter of the requirements of the Design Guidelines for their own purposes. The City of Barstow's decision in matters relating to the same shall be final.

The declaration of Restrictions Grant of Easements (as defined herein) is attached as Exhibit "A". The Purchaser/Lessor is responsible for compliance with the Declaration, as well as with these Design Guidelines, Local local codes, zoning ordinances and other restrictions legally placed against the land; and for causing his contractors, sub contractors, and other agents to comply with these restrictions the same.

The Purchaser/Lessor is responsible to obtain any and all necessary permits from the local authorities to develop parcel and/or building. The Purchaser/Lessor must submit the required number of sets of construction documents and the specifications to each City of Barstow reviewing party, and pay all applicable fees. Copies of permits and one set of approved drawings must be kept at the construction site during construction at all times.



# Section 1: Project Background

## 1.0 INTRODUCTION AND BACKGROUND

### A. Purpose of the Specific Plan

The Spanish Trail Specific Plan is intended to draw upon the cultural and historical heritage of Barstow as a key stopping point along the trade route traversing the southwestern United States from Santa Fe, New Mexico to Los Angeles by creating a mixed-use commercial center that will serve both local residents as well as travelers along the historic corridor that is now manifested by the confluence of Interstate Highways 15 and 40. While acknowledging and paying homage to the city's storied past, the plan looks toward the future by broadening the range of commercial, retail, entertainment, residential, open space and cultural/historical resources available to the residents of and visitors to Barstow.

### I. Historical Background

The 1,200-mile long Old Spanish Trail connected Santa Fe, New Mexico, with Los Angeles, California. The Spanish explored parts of the trail in the late 1700s and New Mexico pack trains used it extensively between 1829 and 1848. The trail was comprised of two primary routes, a northerly path through Utah and a southern passage through Arizona; these two routes converged in the Mojave Desert just east of Barstow at a confluence now roughly demarcated by the intersection of Interstate Highways 15 and 40. In 1829, New Mexican Antonio Armijo led the first mule caravan from Santa Fe to Los Angeles to trade Churro sheep woolen goods for horses and famed California mules. After spending winters trading in California the caravans would return eastward to Santa Fe in the spring when grass was available for the horses and mules to feed on. In 1844, John C. Fremont used the trail to journey east. He recorded it in his journal as the "Spanish Trail", the first known mention of the name. Although the full Spanish Trail became obsolete after 1848 as pioneers, gold seekers, freighters and soldiers established new trails and wagon roads, the original trail continued to be used, primarily by Mormon settlers who established communities and outposts along the way. Subsequently, railroads, highways and power lines have followed roughly the same path originally established as the Old Spanish Trail, thereby retaining its status as one of the most significant transportation corridors in America.

In much the same way that the original travelers along the Old Spanish Trail relied upon Barstow as a resting point en route to Los Angeles and on the return trip to New Mexico, the city of Barstow remains a commonly utilized respite for modern day travelers to and from Las Vegas, Laughlin and points beyond. More than one-third of the interstate traffic makes at least one stop in Barstow for refueling, food, rest and refreshment. Building upon the city's tradition as an interregional way station, the Spanish Trail Specific Plan is intended to provide further inducement to travelers to prolong their stay in Barstow by providing an enhanced retail experience augmented by open space and other uses geared toward highlighting the historical and cultural heritage of the Old Spanish Trail. From the days of the pioneer traders exchanging woolen products from New Mexico for California horses and mules to the modern interstate truckers and recreational travelers who now traverse the route, trading and commerce have long been a focal point of Barstow. Implementation of the Spanish Trail Specific Plan will continue and enhance this tradition as the city maintains and strengthens its historical status as a regional commercial center.

### II. Project Overview

The Spanish Trail Specific Plan project area is delineated by Interstate 15 to the south, the Burlington Northern Santa Fe rail classification yard to the north, K Street to the east and N Street to the west (See Figure 1 – Specific Plan Area Boundaries and Sectors). Within the project area land use designations are grouped into three main sectors. The West Sector, composed of lands located west of L Street and south of Main Street is intended for large-scale ("big box") retail and supporting uses. Lands lying north of Main Street (the North Sector) shall be designated for highway commercial, restaurant and community-serving retail uses, such as travel/fueling centers, "fast casual" restaurants, park and ride facilities, electric vehicle charging stations and retail enterprises serving targeted local demographic segments. The East Sector of the specific plan area located south of Main Street and east of L Street will be comprised of a blend of land uses, including family entertainment, lodging, specialty retail, medium-density residential and open space. Additional information concerning proposed land uses is provided in Chapter 3 – Land Use Plan.



## **1.1 CONTEXT AND CONDITIONS**

### **A. Surrounding Uses**

The Burlington Northern Santa Fe rail classification yard is located to the immediate north of the specific plan area. The classification yard runs parallel to the Mojave River. Lands to the immediate east and west of the project area are occupied by a mix of single-family residential uses and vacant parcels. South of the Interstate 15 border of the specific plan area are low-density residential uses occupying lands that are currently unincorporated; it is anticipated that this area will be annexed to the City of Barstow within the time frame of the 2015 – 2020 Barstow General Plan Update.

### **B. Existing Site Conditions**

The majority of the existing site is currently vacant, with the exception of a Home Depot store located at the northwest intersection of Interstate 15 and L Street, an inoperative service station located on the northeast corner of Main and L Streets, an operating service station on the southwest corner of K and Main Streets and a former truck stop currently being utilized as a restaurant on Main Street at the western periphery of the planning area. Approximately 37 acres in the southeast portion of the project area are presently owned by the federal Bureau of Land Management, a portion of which is occupied by a park and ride lot. Much of the southwest segment of the project area north of the existing Home Depot is held by the State Lands Commission. Lands located north of Main Street are privately held.

### **C. Existing Land Use Designations**

West of L Street the current General Plan land use designation is general commercial in the vicinity of the Home Depot and visitor-serving commercial on the lands north of Home Depot to Main Street. The entire project area north of Main Street is designated for visitor-serving commercial uses. Lands east of L Street and south of Main consist of undesignated CalTrans right-of-way and property designated for neighborhood residential land uses.

### **D. Existing Zoning**

The vast majority of the specific plan area is currently zoned for highway commercial use. A portion of the eastern periphery of the site south of Main Street is zoned for medium density residential use.

### **E. Consistency with General Plan and Zoning**

All of the proposed uses within the specific plan area are consistent with existing general plan land use and zoning designations. A comprehensive revision of the General Plan is currently in process with revisions of the zoning ordinance to follow. In the revised general plan the project area will be designated as the Spanish Trail Specific Plan and the underlying zoning will be identified as a mixed land use district, which will provide maximum flexibility for the blend of commercial, residential and open space land uses that is ultimately developed, provided that such uses, in the aggregate, are consistent with the parameters identified in the specific plan document and accompanying diagrams.

The General Plan Revision and Master Environmental Report is scheduled for completion in March 2015. In the meantime, the proposed uses are consistent with the following policies set forth in the 1997 General Plan:

- I.1.3 Encourage the use of integrated specific or master planned communities which include a range of land use types.
- I.6.1 Encourage development projects which concentrate a range of commercial, public and quasi-public facilities, services and high-density housing in commercial centers.
- I.12.3 Focus economic development activities on “capturing” persons who pass through Barstow on the Interstate Highway.
- I.13.1 The City shall actively seek ways to attract and maintain tourist-oriented commercial and recreational developments.
- II.1.8 Encourage the use of xeriscape landscaping and plantings throughout the city and as an integral



part of all landscape related guidelines, policies, procedures, plans and programs within the city's control.

- II.4.3 Encourage all measures which help reduce the total number of vehicle trips within community.
- IV.2.2 The City shall encourage efforts to collect and preserve available local historical resources.
- V.2.6 Interconnecting areas for pedestrian... and bicycle trails shall be provided throughout the city.
- VI.4.1 Identify, group and create alternative transportation paths as an integral part of existing and proposed roadway system when possible.
- VIII.1.6 Encourage developers to propose innovative measures to reduce air quality impacts, such as bike path and trail systems to facilitate non-vehicular transportation.
- VIII.2.23 Ensure that a comprehensive system of bikeways and pedestrian paths is planned and constructed in accordance with the General Plan.
- VIII.2.24 Ensure that upgrades to existing roads include bicycle and pedestrian improvements.  
With regard to zoning, all of the proposed uses within the specific plan area are consistent with existing zoning designations and are located within or in close proximity to parcels as currently designated on the city zoning map. In summary, no revisions to the existing general plan or zoning ordinance will be required to initiate site development under the proposed specific plan. The Spanish Trail Specific Plan will be formally incorporated into the General Plan Revision and Master Environmental Impact Report at the time of its adoption in March 2015.



## **1.2 LAND USE PLAN**

### **A. Approach**

The specific plan area is ideally suited to address a wide range of local and regional land use needs. The size and depth of the West Sector (lands west of L Street in the vicinity of Home Depot), combined with its adjacency to the L Street/Interstate 15 interchange, make this portion of the project area an attractive site for “big box” retail as evidenced by the fact that Home Depot has already chosen this location. North of Main Street, the location and existing infrastructure lend themselves to highway commercial as well as resident-serving commercial uses; additionally, the site’s location at the western entryway to the nation’s longest remaining Main Street section of historic Route 66 offers promising potential for themed uses such as diners, fueling stations and tourist attractions. The East Sector of the specific plan area located east of L Street and south of Main Street is designed to address a multiplicity of needs, including family entertainment, specialty retail, lodging, medium-density residential along the eastern periphery of the site and open space in the form of a) an interpretive path based on the Old Spanish Trail theme bisecting the sector on an east/west axis perpendicular to L Street; b) a linear pedestrian pathway that provides a buffer and access way for the residential uses to the east, and c) a Class 1 bikeway running from Interstate 15 to Main Street along the east side of L Street.

The Spanish Trail Specific Plan addresses a number of unmet and underserved local and regional demand components that have been identified. Recent retail market analyses suggest that in spite of the existing range and breadth of retail goods and services offered in the Barstow market, surplus demand exists in a variety of market sectors, including warehouse clubs and super stores, sporting goods and hobby stores, furniture and home furnishings, nursery and garden centers and specialty food stores. Local residents also suffer from the relative dearth of family entertainment establishments, medium-density middle-income housing and cultural amenities such as public art, open space and historical attractions. Collectively, the three sectors that comprise the Spanish Trail Specific Plan area contain proposed land uses that are designed to serve many, if not most of these unmet needs.

### **B. Specific Plan Land Use Designations**

The north sector of the specific plan area (lands north of Main Street) is designated for visitor-serving commercial uses (highway commercial). The west sector (lands west of L Street) is designated for general commercial uses and the east sector (lands east of L Street) is designated for mixed uses. Land uses in the east sector shall include commercial, medium-density residential and open space/recreation. Figure 2 – Specific Plan Land Use Diagram illustrates the land use designations for each of the three sectors of the specific plan. Figure 3 – Illustrative Land Use Plan provides a more precise visual representation of the intended mix of land uses throughout the specific plan area. Given the market-driven nature of urban development it is recognized that actual uses developed within the specific plan area and the location of these uses are likely to vary somewhat from those shown on the illustrative land use plan, provided that the relative proportion of lands assigned to the various uses remains consistent with the overall plan.

### **C. Land Use Objectives**

- I. Develop project area in a manner that addresses local needs for retail goods and services, family entertainment, open space and cultural enrichment.
- II. Enhance the city’s sales tax revenue base by facilitating the development of additional highway commercial and “big box” retail establishments.



## **1.3 CIRCULATION**

### **A. External Circulation**

The external circulation of the project area is designed to tie into the city's overall vehicular, bicycle and pedestrian circulation network. L Street between I-15 and Main Street shall remain designated as a primary arterial roadway and this portion of the roadway shall be renamed "Spanish Trail Parkway". Completion of the project will entail the creation of two additional four-way, signalized intersections on Spanish Trail Parkway. Additionally, a Class 1 bicycle pathway will be designated and installed along the east side of Spanish Trail Parkway that will connect with the citywide bicycle pathway network.

### **B. Internal Circulation**

A meandering collector road (Armijo Drive, named for the New Mexican trader who first traversed the Old Spanish Trail through Barstow) will form the axis of the internal roadway network, entering the specific plan area from Main Street approximately 400 feet west of K Street, gradually curving westward to form an intersection with Spanish Trail Parkway (L Street) before bisecting the east sector of the specific plan area north of the existing Home Depot. Radiating from this collector will be a series of local streets, each named for one of the early traders known to have traveled the Old Spanish Trail during the peak of its initial usage from 1829-1848. Armijo Drive will be designated as a Class 3 bicycle route (signage only), connecting with the Class 1 bicycle route along Spanish Trail Parkway and the Class 2 bikeway along Main. Concerning pedestrian traffic, city sidewalks within the specific plan area will be augmented by an interpretive pathway approximately ¼ mile in length that will roughly divide the north and south portions of the mixed-use (east) sector, intersecting with a linear pedestrian pathway along the rear property lines of the medium-density residential uses on the eastern periphery of the project area. (See Figure 3) The interpretive trail will be landscaped with native trees and vegetation similar to that which existed during the formative years of the Old Spanish Trail, accompanied by signage denoting its natural and cultural history.

### **C. Circulation Objectives**

- I. Design internal circulation network to minimize intra-area motor vehicle travel by:
  - Linking sectors of the specific plan area with visible and accessible pedestrian pathways.
  - Clustering commercial structures to encourage walking between establishments.
  - Providing accessible bike racks throughout the specific plan area.
- II. Promote pedestrian, bicycle and public transportation travel to and from the area by:
  - Linking the site to the citywide bicycle route network.
  - Locating at least one bus stop adjacent to the specific plan area.Connecting local sidewalks to the internal pedestrian circulation network.
- III. Encourage travel to the area via carpool and alternative fuel vehicles by:
  - Locating a high-speed electric vehicle charging station within the project area.
  - Locating a park-and-ride lot within the project area.
  - Providing designated carpool parking spaces in the vicinity of family entertainment uses.





## **1.4 OPEN SPACE, CULTURAL AND HISTORICAL RESOURCES**

### **A. Approach**

In addition to enhancing the range of retail goods and services available to local residents and expanding the city's capture of sales tax revenues derived from interregional travelers, the Spanish Trail Specific Plan is designed to provide accessible public open space and to accentuate the historical and cultural heritage of the community. Project features such as the interpretive pathway, a linear pedestrian corridor providing access from the medium density residential uses along the eastern periphery of the project area and three dimensional public art highlighting the historical significance of the Old Spanish Trail will entice visitors to the area while enriching the community's inventory of cultural and historical resources. This approach to open space, cultural and historical resource preservation is warranted in light of both the close proximity of the project area to the nationally designated Old Spanish Trail as well as the fact that a significant proportion of the existing site currently falls under the stewardship of the federal Bureau of Land Management, one of the agency partners of the Old Spanish Trail Association.

### **B. Open Space, Cultural and Historical Resources Objectives**

- I. Incorporate an interpretive pathway with signage and landscaping denoting significant individuals who traveled the Old Spanish Trail as well as the flora and fauna that the original travelers are likely to have encountered along the trail.
- II. Provide additional open space in the form of a landscaped pedestrian corridor along the eastern periphery of the project area.
- III. Commission and erect a statue at a prominent location within the specific plan area honoring one or more of the individuals (such as General John C. Fremont, Antonio Armijo or Julian Chavez) or animals (such as pack mules) that played a significant role in the development and use of the Old Spanish Trail.







EXHIBIT 3.1 Masterplan



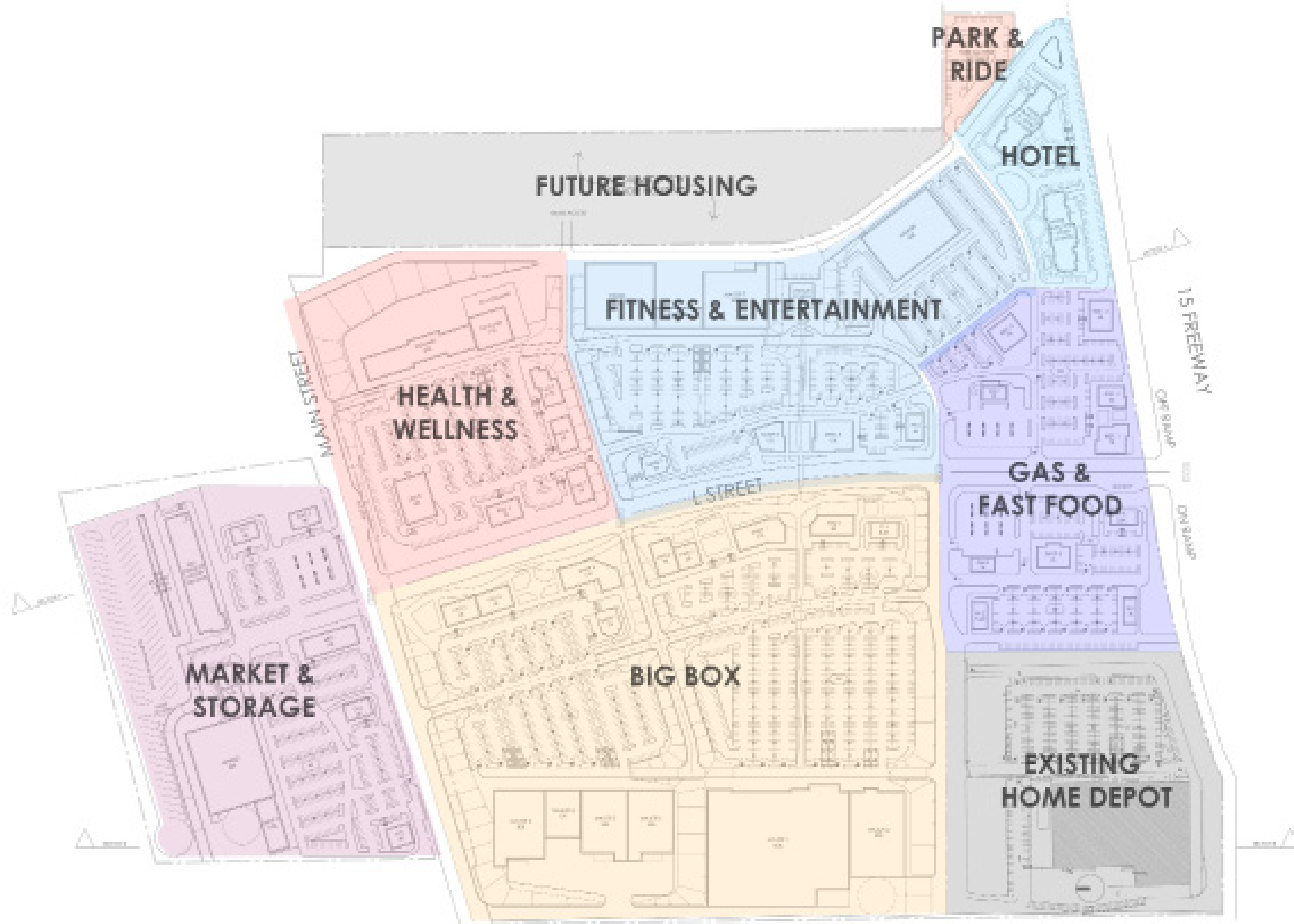

Exhibit 3.2 Parcel Type Plan

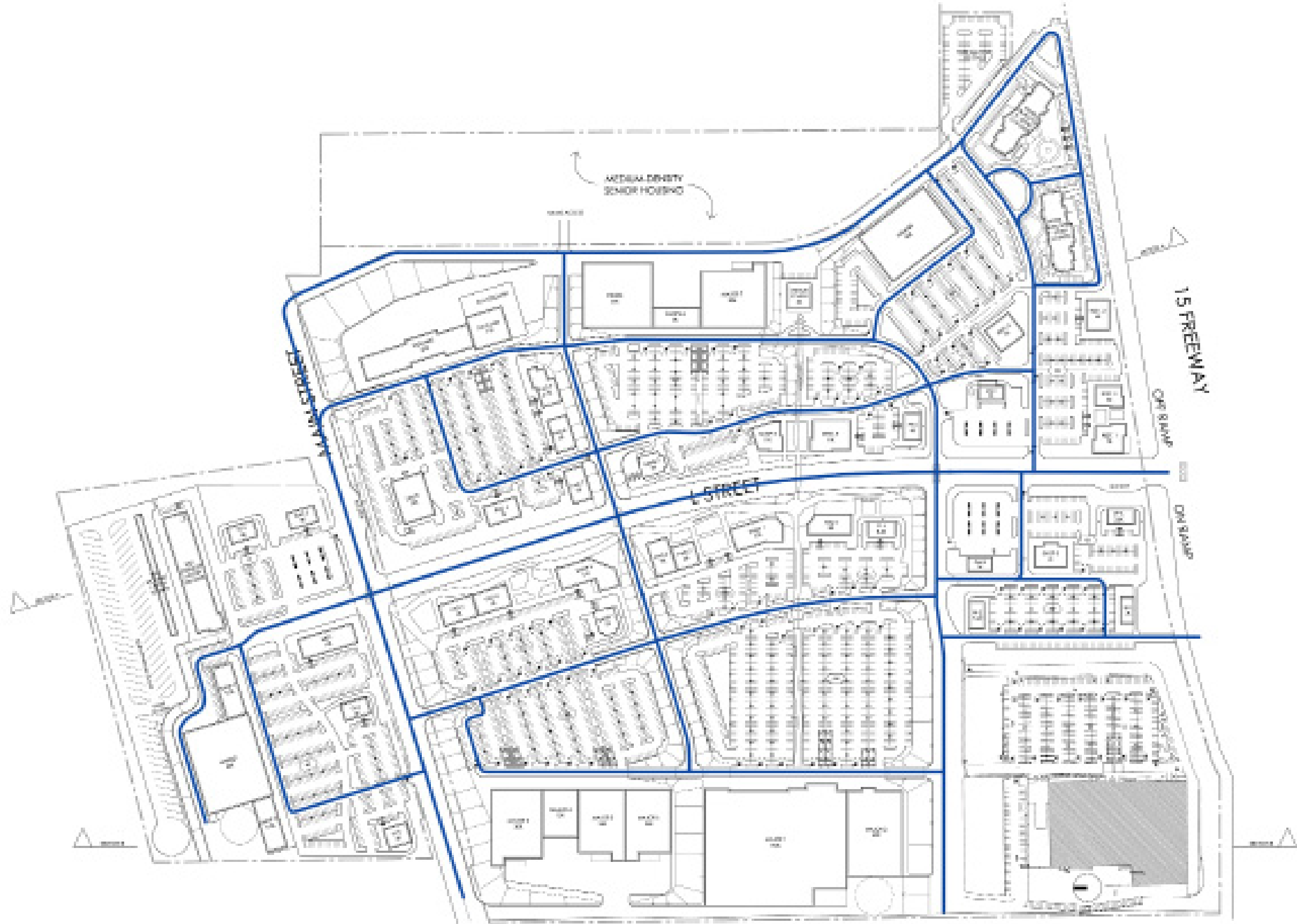

Exhibit 3.3 Truck Access Plan



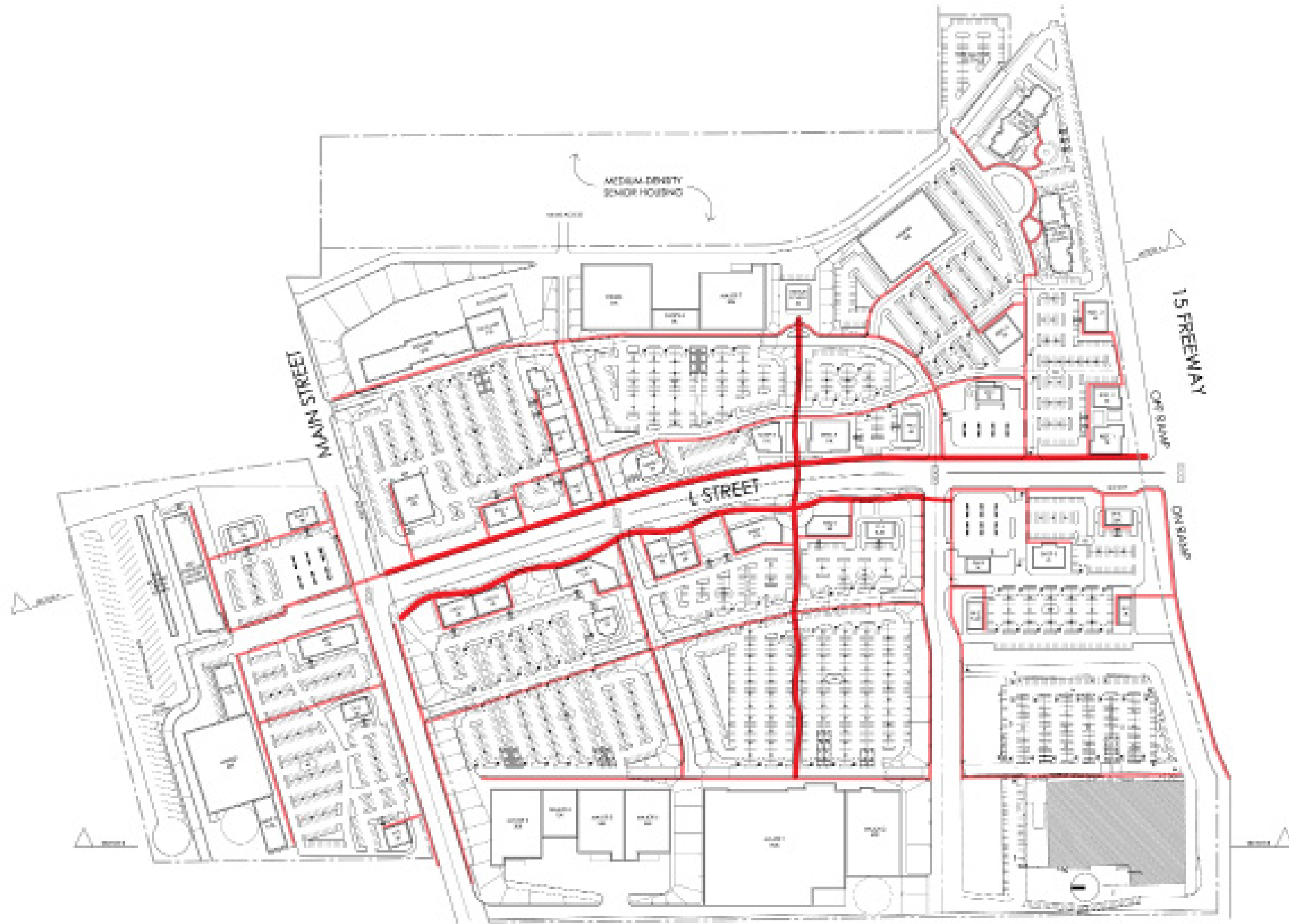

Exhibit 3.4 Pedestrian Access Plan

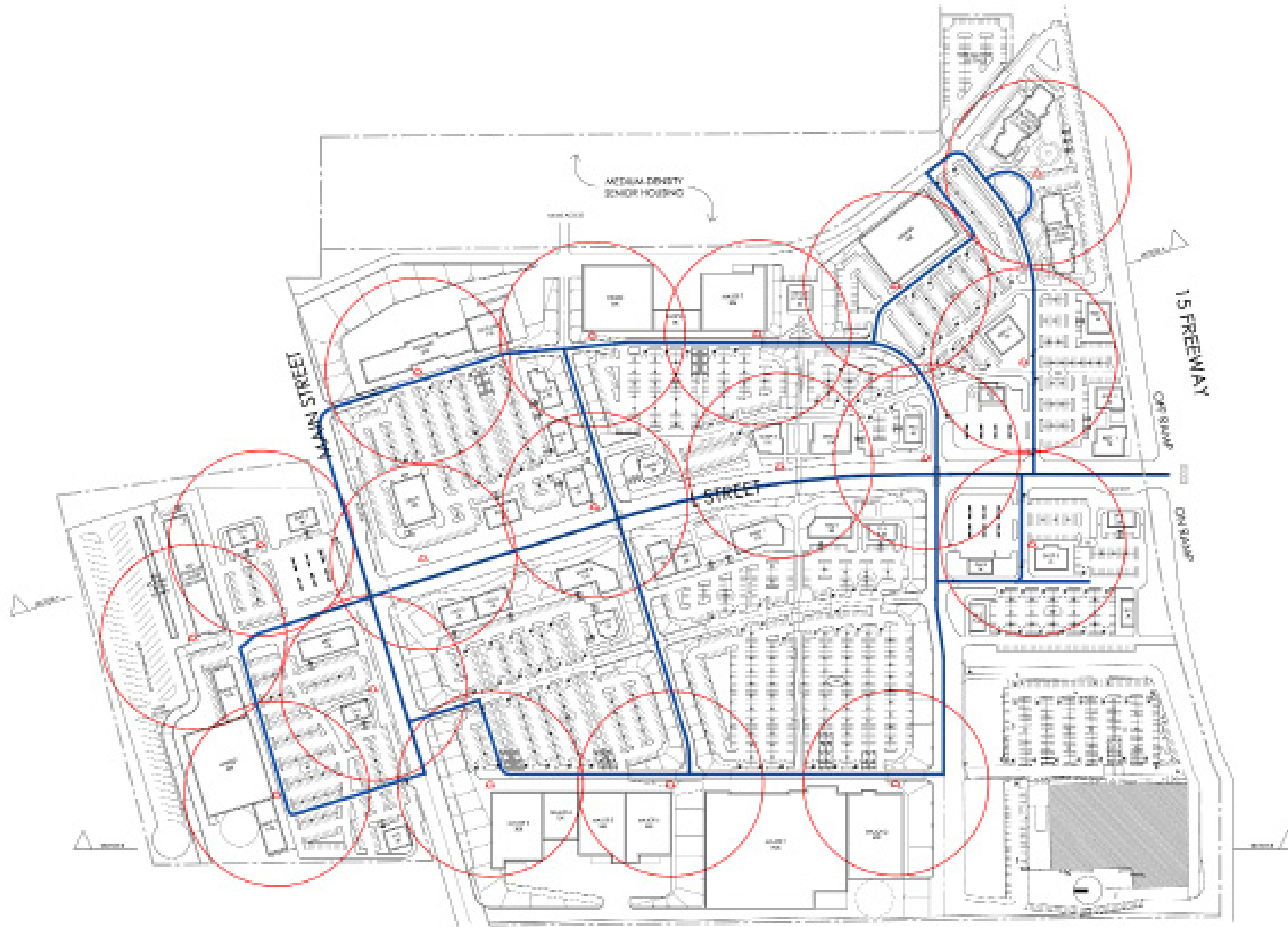

Exhibit 3.5 Fire Hydrant Access Plan



Exhibit 3.6 Transit Stop and Bike Path Plan

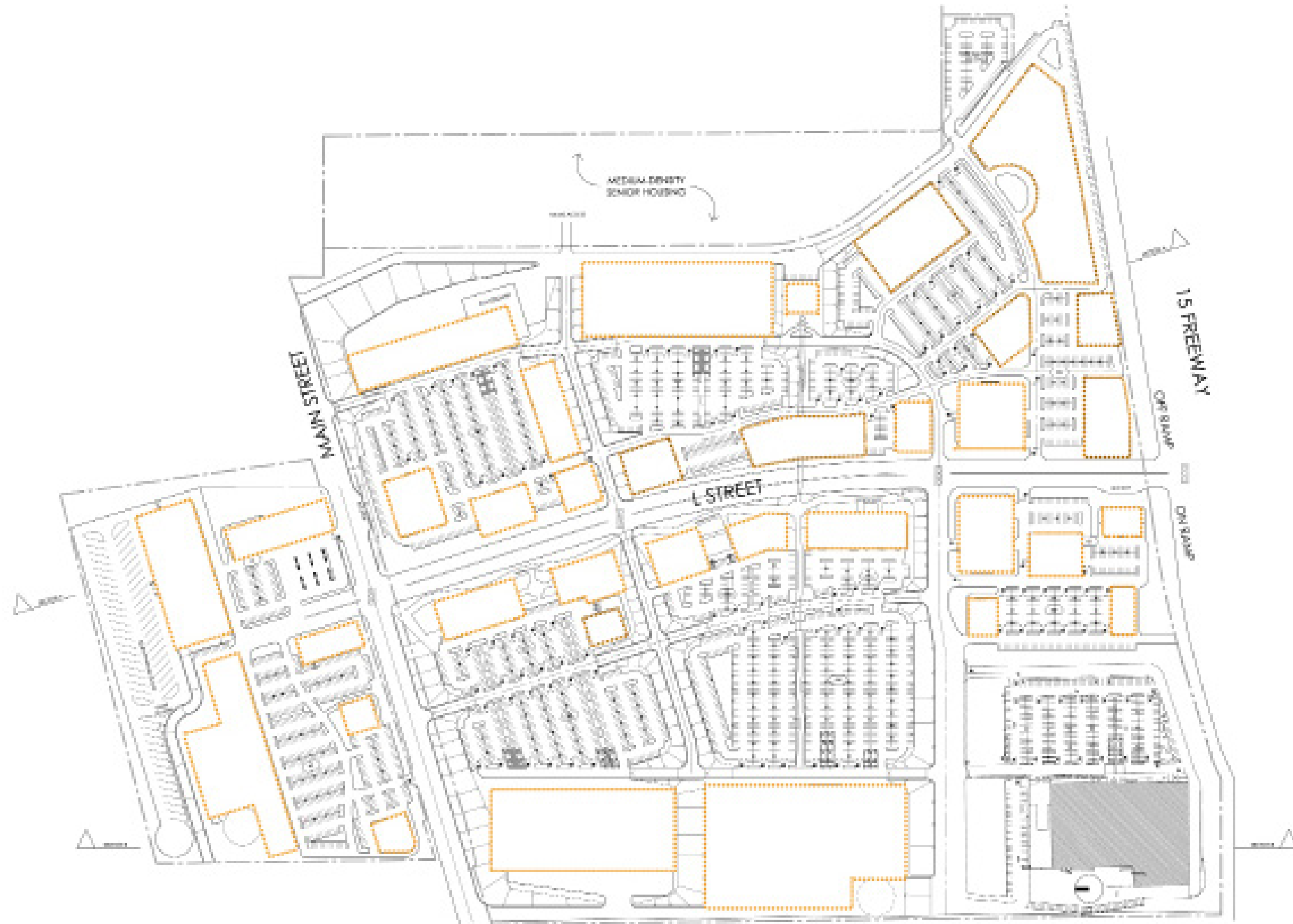
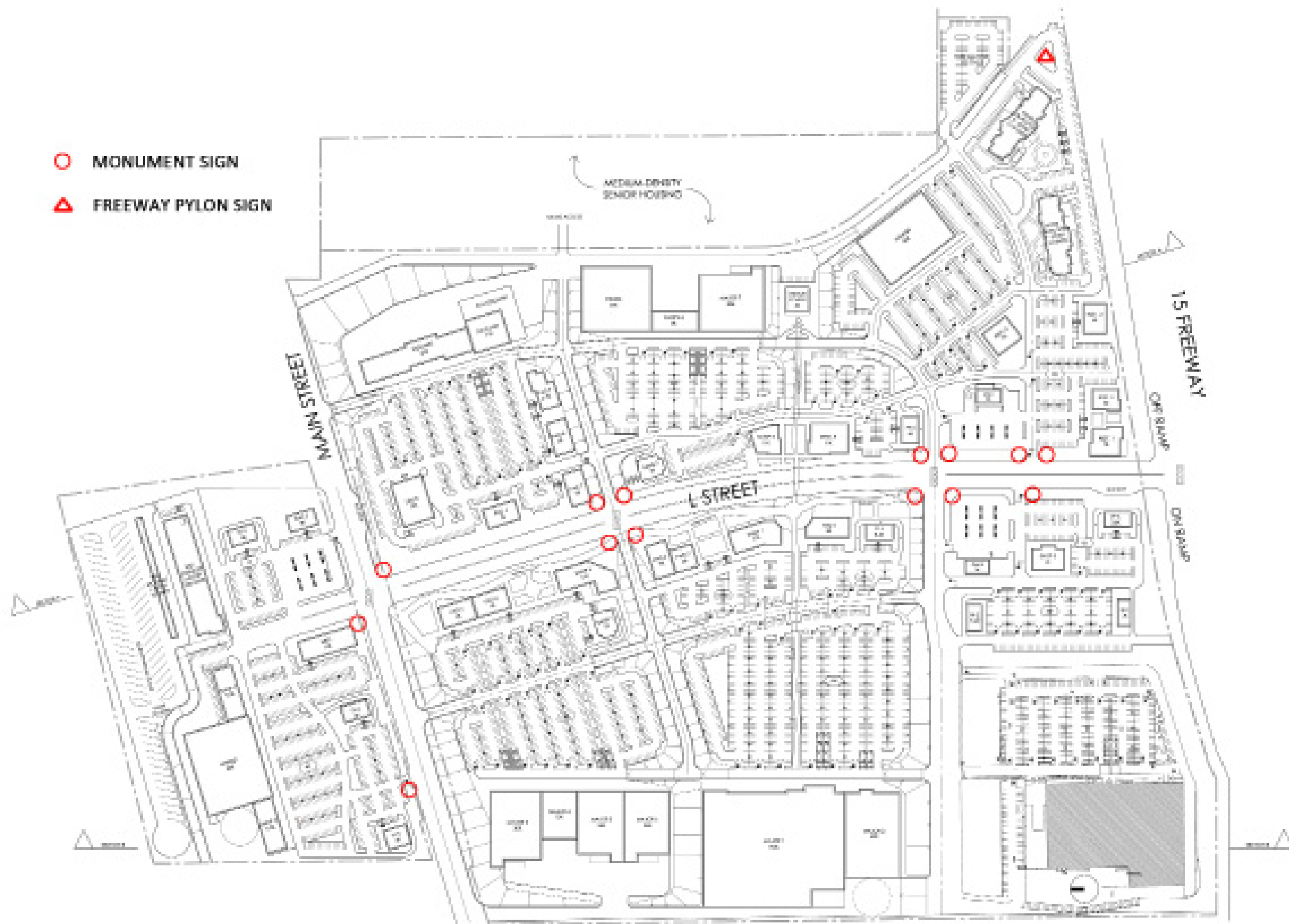

Exhibit 3.7 Buildable Area Plan





- MONUMENT SIGN
- ▲ FREEWAY PYLON SIGN

Exhibit 3.8 Monument Sign Plan









# SHOPPES AT SPANISH TRAIL DESIGN GUIDELINES

DECEMBER 10, 2013

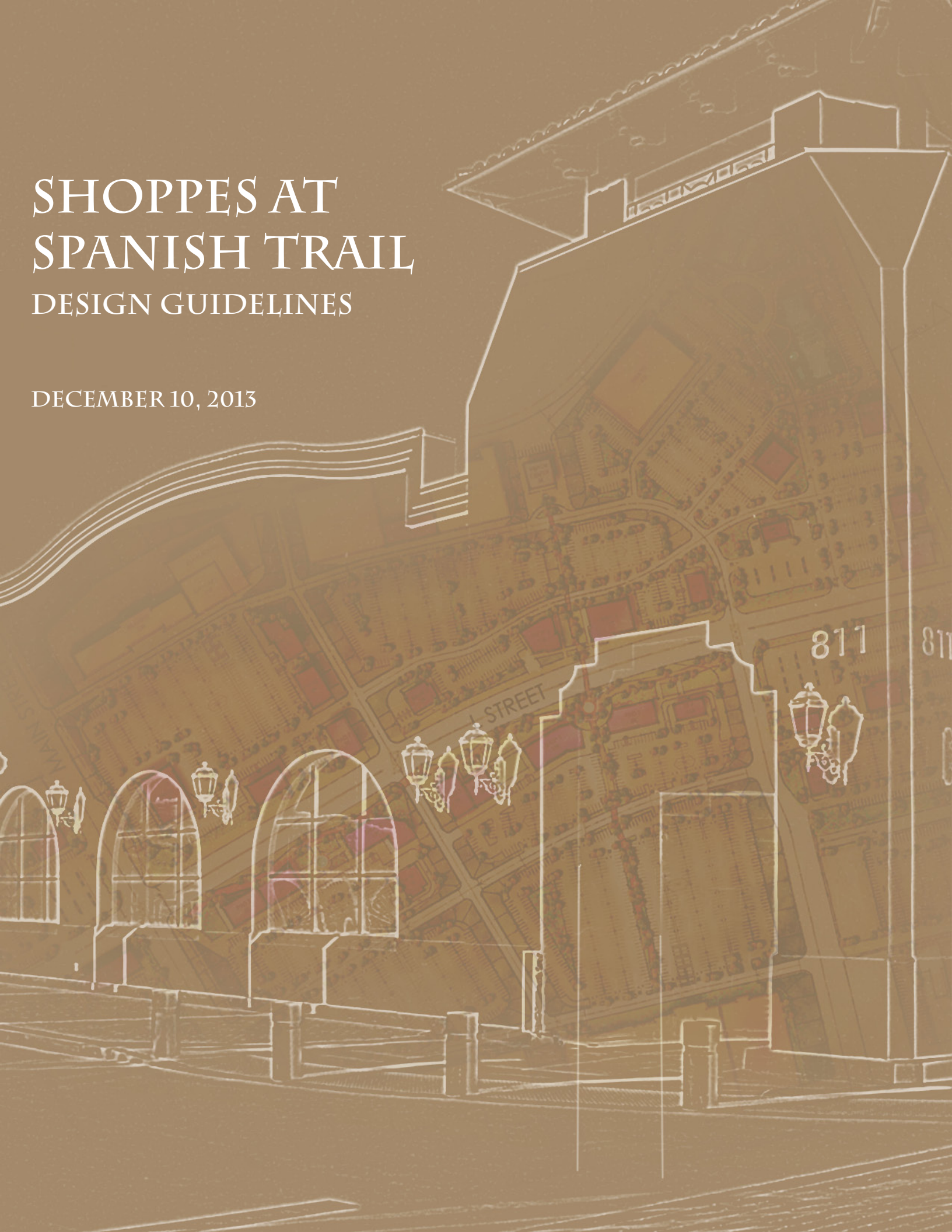

# Table of Contents:

## Section 3: General Information

- 3.1 Seller's Coordinating Staff
- 3.2 Partial List of of Governmental Agencies and Public Utilities
- 3.3 Tenant Handbook Glossary of Terms
- 3.4 Document Requirements
- 3.5 Lot Line Adjustment
- 3.6 Final Construction Requirements
- 3.7 Construction

## Section 4: Design Guidelines

- 4.1 Site Development
- 4.2 Building Development
- 4.3 Sign Criteria
- 4.4 Landscaping

# Section 3: General Information

## 3.1 SELLERS COORDINATING STAFF

### **Development Manager**

Contact: To be determined  
Malcolm Riley and Associates  
12100 Wilshire Blvd  
Ste 800  
Los Angeles, CA 90025  
T. (310) 472-4281

### **Architect:**

Contact: Mark Giles, AIA  
DLR Group  
117 E. Colorado Boulevard  
5th Floor.  
Pasadena, CA 91105  
T. (626) 796-8230  
F. (626) 796-8735

### **Reviewing Engineer**

Contact: Brad Merrell  
Merrell Johnson Companies  
22221 U.S. Highway 18  
Apple Valley, Ca. 92307-3920  
T. 760.240.8000

### **Landscape Architect**

Contact: Robert Curley  
Cummings Curley and Associates  
3633 Long Beach Boulevard,  
Suite 300  
Long Beach, California 90807  
T. (562) 424-8182

### **Sign Consultant**

Contact: TBD

### **Construction Supervisor**

To be provided



## **3.2 PARTIAL LIST OF GOVERNMENTAL AGENCIES AND PUBLIC UTILITIES**

### **Department of Building and Safety**

Contact: To be Determined  
220 East Mountain View Street  
Suite A  
Barstow, CA 92311  
T. (760) 255-5161

### **Department of Planning & Zoning**

Contact: Gaither Loewenstein  
220 East Mountain View Street  
Suite A  
Barstow, CA 92311  
T. (760) 255-5152

### **Department of Engineering**

Contact: To Be Determined  
220 East Mountain View Street  
Suite A  
Barstow, CA 92311  
T. (760) 255-5156

### **Barstow Fire Protection District:**

861 Barstow Road  
Barstow, CA 92311  
(760) 256-2254

## **Utilities**

### **Electric Company**

Southern California Edison  
Tony Zavala  
T. (760) 694-7205

### **Gas Company**

Southwest Gas  
13471 Mariposa Road  
Victorville, CA 92395-5315  
Kurt Edwards  
T. (760) 951-4033 or (760) 780-2894

### **Water**

Golden State Water  
1521 E Main St  
Barstow, CA 92311  
(760) 256-2275

### **Sewer**

Barstow Wastewater Department  
220 E Mountain View St  
Barstow, CA 92311  
(760) 255-5161

### **Telephone**

Verizon Communications



## **3.3 TENANT HANDBOOK GLOSSARY**

### **A.I.A.**

American Institute of Architects

### **As-Built Survey**

Document showing completed physical conditions and improvements to project.

### **Building Coverage**

The ground floor gross building area divided by the site area.

### **Changeable Panels**

Sign panels which contain advertising information, copy, forms, or images that are intended to be removed in whole or part, changed and replaced with new advertising information, copy, forms, or images., whether by manual or automatic means. A change in the sign panel is subject to City of Barstow review and approval.

### **Contour Lines**

Drawn lines on a plan that connects the elevation heights of an actual or proposed surface.

### **Contract Documents**

Working drawings and specifications of a physical project as part of the contractual agreement directed toward the construction and subsequent completion of the project. Defined in detail in A.I.A. document A201.

### **Declaration of Restrictions and Grant of Easements**

Document recorded against the property and running with the land granting specific rights and obligations to the Outlot Purchaser.

### **Landscaping**

Consists of any of the following combination of materials such as, but not limited to, grass, ground covers, shrubs, vines, hedges, trees, or other live plant matter. Non-live material such as rocks, pebbles, mulches, fences, walls, pavers, benches, irrigation systems, and other site amenities are also to be considered landscaping.

### **Magazine Road**

A transition road intersecting and leading from, a major public road to the major drive/road in the development. Such a transition road allows for regulated and orderly directing of cars into and out of the development property.

### **Monument Sign**

A monolithic sign and base structure, freestanding, and installed in a landscaped area.

### **Malcolm Riley and Associates**

Authorized agent for the owner and developer of Shoppes at Spanish Trail project. At the option of the agent, additional parties may be designated to perform review of Purchasers/Lessor Contract Documents.

### **Purchasers/Lessor Developer**

Any and all owners, tenants, sub-tenants, concessionaires, or occupants of a parcel of land/building and thereby subject to the these criteria.

### **Parking Stall**

A standard, dimensioned rectilinear space for the parking of a vehicle per the City of Barstow Public Works standards and/or tenant standards..



## **Permissible Building Area**

Specific area designated for the location of above-ground structures such as buildings. Generally, the boundaries are determined by setbacks, landscape areas, parking areas, or as shown in the dedication.

## **Pylon Sign**

A sign with the appearance of being supported from the ground by a single separate constructed support member. The use of pylon signs is not permitted on Phase 1 of the proposed development

## **Reciprocal Easement Agreement**

Any and all purchase agreements, leases, exhibits, supplemental agreements, and similar documents restricting or affecting title to the subject parcel.

## **Ring Road**

The road which surrounds a shopping center and parking lots and connects to the magazine roads

## **Rooftop Sign**

Sign supported by a structure or fasteners mounted to and/or directly on or above a roof deck or slope. The use of a roof top sign is not permitted.

## **Setback**

A required minimum distance between a structure or other use and a property line or determined point.

## **Shop Drawings**

Detailed drawings showing dimensions, materials, colors, finishes, and construction of fabricated items. Generally prepared by the material fabricator.

## **Striping**

Refers to painted line work on parking, loading and driving surfaces showing parking stalls, traffic direction, and regulation of vehicles.

## **Vehicle Stacking**

An orderly space allowance for a number of cars or trucks, waiting to use drive-up facilities, or traffic control points such as stop signs, lights, pick up lanes, left turn lanes, deceleration and/or acceleration lanes.

## **Site Plan/Preliminary Design**

The Purpose of this phase is to acquaint the City of Barstow with the Purchaser/Lessor intentions so that the City may comment and/or advise the Purchaser/Lessor of any changes necessary to meet the criteria before the final contract document phase. Sketches, perspectives, sections or other details that will clarify the information presented is desirable. City of Barstow's review of the preliminary package should normally take one to two weeks from receipt of the documents.

After City of Barstow's review and approval, the Purchaser/Lessor shall present their package to the City of Barstow for review and approval of the development plan.



## Final Construction Documents

After the Preliminary design drawings have been approved, the Purchaser/Lessor architect shall proceed with the preparation of final contract documents and specifications. Incorporating design suggestions and comments recommended by and approval by the City of Barstow in accordance with the criteria contained in this Handbook. Review time at this stage is normally two weeks from the receipt of the documents. Generally, City of Barstow's review is linked to ensuring conformance with previous approvals and the design criteria as specified in this document.

After City of Barstow's review and approval the Purchaser/Lessor shall present such plans to the City for a Building Permit Application.

## Construction

The construction of the Purchaser/Lessor project will be monitored by the City of Barstow to assist in the coordination of construction activities with other activities or uses of the development. See Section 4, "Construction Coordination." Such monitoring shall not be deemed an assumption by the City of Barstow, or its agents of responsibility for construction supervision of the project.

The Purchaser/Lessor shall supply an as-built set of Site documents and a copy of the Certificate of Occupancy.

## 3.4 DOCUMENT REQUIREMENTS

Purchaser/Lessor shall contact the City of Barstow for exact submittal requirements. The following minimum information is required for each phase of the review process:

### Site Plan/Preliminary Design

- A. Site Plan  
Title, date, consultant, Purchaser/Lessor and sheet number.

Scale at 1" = 20'-0" minimum, and show North arrow OR City of Barstow Standard.

Key plan – a small scale plan is to be included showing location of project in relation to the total development.

Parking data – number and ratio of spaces provided, size of stalls and aisles, and striping and angles of parking.

Acreage with building coverage and landscaping coverage and rough parcel dimensions.

Location of any view corridors, building setbacks, dimensioned property lines, easements, building area, and other restrictions on the property. Show also any prominent existing physical features to remain.

Building layout, pedestrian and vehicular circulation features within the property, and layout of parking areas. Also, service locations, including trash collection areas, screening methods, loading and unloading zones, and the locations of entries and curb cuts are to be shown.

Spot elevations or grading plans sufficient to indicate proposed grades for entire property development, including building floor elevations. Indicate surface drainage patterns, and storm water inlets, and any retaining walls that will be required.

Location and number of all signs

Utilities, utility locations, and connections to existing utilities and to the building.

The site plan must comply with all material requests with the overall site plan approved by the City of Barstow.

**B. Site Lighting**

Fixtures and poles matching the style of the development's parking Light fixtures.

**C. Landscape plans**

Plan to be at a scale of 1" = 20'-0" minimum OR City of Barstow Standard. Details and special planning areas to be prepared at a larger scale.

Title, date, consultant, Outparcel Developer, and sheet number.

Key plan – a small scale plan is to be included showing location of project in relation to the total development.

Dimensions, property lines, setbacks, easements, contour lines, elevations and prominent physical features.

Location of building(s), driveway(s), curb cut(s), parking, pedestrian, and service areas.

Location and types of hard construction materials, furniture, lighting, and other amenities that shall match the development's site amenities.

Irrigation – indicate type of system and irrigated areas.

Plant materials – Show quantity, botanical and common names, container size, and location of materials with clearly drawn labeled symbols. A minimum landscaped coverage of 15 Percent of the open area is required of all outparcels. Reference Section 3 for criteria requirements.

**D. Building Plans**

Title, Consultant, Outparcel Developer, date, and sheet number.

Scale 1/8" = 1'-0" minimum, also show North arrow OR City of Barstow Standard.

Building data – Type and use, square footage, number of seats (where applicable) building area (by use).

Floor plans with Dimensions.

Elevations with Dimensions (show building height); specified materials, and colors.

All proposed signage on building.

Cross and longitudinal building sections.

Utility loads and points of connection

**E. Signage**

Plan showing size and location of all proposed signs in accordance with criteria.

Elevations and sections showing all dimensions, materials, colors, and methods of illumination.

Photographs of identical or similar signs from previous projects.

**F. Lighting**

Plan showing all dimensions, materials, parking light fixture cut sheet, colors and methods of illumination.

Photographs of identical or similar lighting from previous projects.

### **3.5 LOT LINE ADJUSTMENT**

Lot Line Adjustment Drawing showing dimensioned adjustment to the parcel map in accordance with the City of Barstow requirements. Title Report, Metes and Bounds Descriptions as necessary. File Tax Bond may be required at Purchasor's/ Lessor's sole expense.

### **3.6 FINAL CONSTRUCTION DOCUMENTS**

- A. **Site Plan**  
Complete working drawings and specifications prepared by a registered architect, engineer, landscape architect, or other consultant.
- B. **Precise Grading Plan**  
Plan Showing elevations and drainage methods of all surfaces. Includes tie – in into public storm drains and hydrology and hydraulic calculations.
- C. **Landscape Plan**  
Complete working drawings, details, and specifications including plant list as prepared by a registered landscape architect. Irrigation plans showing all landscape areas on an automatic irrigation system. Show common and botanical names of all plant materials, and sizes.

The Irrigation Legend shall indicate:

- Symbols
- Descriptions
- Manufacturer's name and model numbers
- Operation pressures
- Gallons per minute
- Sprinkler radii

Legend Items are to be keyed on plans by manufacturer's model number, detailed reference, and specific reference, as required.

Plans are to show all utility locations and specifically define contractor's responsibility.

Plans are also to include the following information:

- Location of water meter
  - Water meter and size
  - Elevation
  - Residual pressure (minimum, and maximum P.S.I.)
  - Domestic maximum demand (g.p.m.)
  - Irrigation area served (S.F.)
  - Estimated water consumption per month and year

All valve call – outs are to show controller sequence, valve-size, and system flow in gallons per minute. When electrical service is required, indicate requirements and the party responsible for providing service.

Complete comprehensive specifications are to be submitted identifying the scope of work to be provided. Also, a proposed operation schedule is to be submitted with plans.

Irrigation plans are to be prepared, signed, and dated by a qualified landscape architect or irrigation consultant.

- D. **Building plans**  
Complete working drawings and specifications as prepared by a registered architect.

A sample palette of major exterior building materials and colors shall be submitted.

- E. Signage**  
The construction documents for signage. Outparcel Developer is responsible to obtain all necessary sign approvals, and permits from the City of Barstow.
- F. Utility Plans**  
Plans showing locations of all utility service connections and facilities. The Outparcel Developers shall be responsible in drafting these plans in conformance with the requirements of each utility provider and to obtain their approvals.
- G. Lighting**  
The site lighting drawings must accompany final working drawings for review.  
  
Complete shop drawings of all site lighting, including photometric and manufacturer's literature, must be submitted for review and approval prior to installation.

### **3.7 CONSTRUCTION**

- A. Utility and Truck Access  
Show the routing of temporary utilities to be used during construction. Show access routes for construction traffic. Also see Section 4.
- B. Record Site Drawings  
"Record" survey showing all above and below grade Improvements.



# Section 4: Design Guidelines

## A. Introduction

This section of the Design Guidelines describes the Design Standards and Guidelines for development of Purchaser/Lessor buildings and for building not constructed by Purchaser/Lessor.

## B. Site Access and Traffic Flow

Shoppes at Spanish Trail in Barstow is located on the intersection of L Street between Main Street. Access to the site may be from the L Street exit off the 15 Freeway or from Main Street. See Exhibit 3.1 for the general site layout.

For out parcel development and tenant developed buildings, scope of work shall generally be from inside face of curb unless a limit of work line has been established with the City of Barstow prior to the start of construction. Should the scope of work include a portion of site development, the location of drive aisles, parking stalls, planters, trash enclosures shall be in conformance with the overall site plan and this design guidelines and may be subject to City of Barstow approval.

Entrances directing traffic to a “head – on” parking condition are to be avoided.

Drive – through facilities are to allow for sufficient vehicle stacking distance (current Development Code requirement is six car lengths from the order box, which shall be the minimum stacking allowed) and should be remote from parcel access points.

Asphalt curbs are not permitted in any location within the development.

All curb returns for access driveways are to have a 15'-0" minimum radius.

Service access for semi tractor – trailer or fire trucks requires wider driveways and greater radii and shall be designed accordingly. See Exhibit 3.2 for Truck Access.

All Pedestrian access is to be clearly identified. Should pedestrian access cross a landscaped area, it is to be via a 5'-0" wide (clear dimension) hard surfaced sidewalk. Should pedestrian access cross a drive aisle, the access point shall be clearly marked as a pedestrian cross walk. See Exhibit 3.3 for pedestrian access.

Site requirements, as well as all other design concerns included herein, may require modification or coordination in order to accommodate multiple operators on one parcel.

Access drives may be shared with the adjacent property owner/user. Purchasers/Lessor are required to open and align parking drives to the adjacent property parking lot to facilitate access/egress.

## C. Site Parking

All required customer and employee parking is to be accommodated on each parcel. All standard parking spaces are to be 9' x 18' with minimum 63' wide bays. Parking angle is to be 90 degrees. Parking must also satisfy the City of Barstow zoning ordinances and codes, but shall not be less than 4.5 spaces per 1,000 square feet of retail spaces, and 10.0 spaces for every 1,000 square feet of seating area in restaurants for the first 5,000 sf. and 15.0 spaces for every 1,000 square feet of seating area above 5,000 sf. See Exhibit 3.1 for the general site layout and parking areas.

Handicapped parking spaces are to be provided in accordance with local codes and the American Disabilities Act as well as California Title 24 requirements.

In general, it is desirable to have parking aisles that are to be perpendicular to the building.

Whenever possible, curbed islands are to separate a change in direction of parking stalls and aisles.

The pavement section of parking areas are to conform to the minimum pavement sections as specified in the soils report and City of Barstow Requirements. All parking pavement is to be asphalt pavement. Decorative/accent paving may be in stamped/scored concrete and/or pavers. The City must approve any decorative paving. Trash enclosures and adjacent truck service areas shall be constructed of concrete pavement.

Heavy traffic lanes are to be provided with a heavy duty pavement section per the soils report specifications.

All paved areas shall receive a curb or a curb and gutter section at all terminations. Type of curb shall conform to the curb section used on the general parking area. Minimum height of curb or curb and gutter above paved area shall be six inches.

4" (Four inch) thick concrete sidewalks are to be provided along the front of all buildings and where otherwise necessary by Purchasers/Lessor or per soils report. In some instances, a pedestrian travel way may be required from the public streets to the ring road through the Purchasers/Lessor property. The walks are to be broom finished.

Handicapped ramps are to be provided and constructed as required by local codes and the Americans with Disabilities Act and Title 24 of the California Code of Regulations.

Purchasor/Lessor paving, curb, walk and gutter operations are not to commence prior to the installation of underground utilities. Paving operations and utility installation is to be coordinated with the Construction Manager so that such installation does not cause unnecessary inconvenience to shopping center operations, or pedestrian or vehicular traffic.

#### **E. Site Lighting**

The design of the site and building lighting for the Shoppes at Spanish Trail should carefully consider enhancing the architectural theme of the project while providing for the safety, security, and privacy of other.

1. All parking lot lighting fixtures are to match the style of the developer's/site standard. Outdoor lighting shall conform to city ordinances.
2. Light poles are restricted to 35' in height maximum, including the base, or as otherwise required by code. In addition, light poles under the Southern California Edison shall be per Southern California Edison height restrictions and locations. Light pole bases must be 36" high concrete to protect light poles from damage.
3. Architectural wall mounted light fixtures shall enhance the architectural theme of the project and be consistent with the style of architecture.
4. Security wall mounted light fixtures shall be dark bronze or painted to match the building exterior. Security lighting shall be fully shielded.
5. Outdoor/landscape lighting is encouraged to highlight monument sign, building signage, architectural features, or landscape features such as ornamental trees, pathways, or pedestrian
6. Illumination is to be not less than 2.00 foot-candles minimum maintained throughout the parking lot.
7. See Exhibit 3.4 for Site Lighting Photometric Plan.

#### **F. Site Utilities**

Generally, all utility services shall be screened by landscaping, including water meters and backflow preventers.

All gas meters are to be concealed from public view, where possible.

All electrical and telephone service, except transformers and meters, are to be installed at the rear of building and/



or in the building, where possible. All meters and transformers are to be reasonably concealed from public view, but in conformance with electric company requirements.

All utilities shall be installed with minimal visible exterior connections to parcel facilities except for required meters or transformers. Meters and transformers are to be screened with masonry walls and/or plant material where possible.

#### **G. Grading and Drainage**

The parcel shall be graded to provide positive drainage to the storm sewer system that has been sized to receive parcel discharge. The storm drain system is designed to a 2-year storm level. All buildings shall have 100-year flood protection through a combination of site grading and storm drain facilities. The Purchasor's/Lessor's engineer shall coordinate the precise grading design with adjacent parcels. All necessary erosion control methods will be utilized during construction to avoid siltation onto adjacent properties and into pipelines. Stock piling of topsoil or excessive material is not to interfere with drainage before, during or after construction.

No modifications to the approved surface drainage pattern will be permitted. Existing drainage areas are not to be altered during the grading sequence or afterwards unless accepted by and the City of Barstow.

Parking lot slopes shall be a minimum of one (1) percent and a maximum of five (5) percent unless the City imposes more stringent requirements. All trenches or excavation near or adjacent to existing curbs, sidewalks, and pavement should be properly protected during excavation and shall be backfilled with suitable backfill material. Required density of compaction is to be indicated on the plans or specifications.

#### **H. Building Architectural Design**

Purchasor/Lessor and the designated architect shall review the illustrations of Shoppes at Spanish Trail's exterior elevations and entrances that are included in this document to maintain conformity to the design intent. Purchasor/Lessor may unique national branding that will receive special consideration and approval so long as the concept meets the spirit of the Design Guidelines.

#### **Building Wall Height and Treatment**

Outparcel buildings shall not exceed 28 feet above finish grade at the primary building parapet. Entry features, towers, architectural projects may be taller, but shall not exceed 40'. See Exhibit 3.6 for a typical shop elevations and Exhibit 3.7 for a typical pad elevation.

The Shoppes at Spanish Trail has treated its stucco walls with color and pattern; the wall pattern is created with reveals, stone medallions and special fixtures. See Exhibit 3.8 for wall treatments. Similar treatments are required for outparcel buildings, in order to add interest and detail. Where flat roofs are used the building wall should end in an 18" – 30" high decorative cornice detailed similar. Sloping roofs shall be used and shall utilize clay mission tile, to break up the massing of the building. See Exhibit 3.9 for conceptual wall sections.

Light-colored stucco or stone accents, and columns, smooth and split faced masonry, heavy timber canopies, wood trellis', etc. create the integrated aesthetics of Shoppes at Spanish Trail. Similar or identical materials, finishes, and color will unify the development. Metal canopies and/or fabric awnings are encouraged

#### **Screen Walls**

Screen walls are used on buildings to conceal service areas. Screen walls shall be constructed of concrete masonry units with a light sand plaster finish with foam cornice treatment.

#### **Materials and Colors**

Purchasor/Lessor buildings shall utilize materials, finishes, and colors which match or complement the Shoppes

at Spanish Trail, For colors/material, see Exhibit 3.10 Light-colored, light sand finish plaster or stone accents, and columns, smooth and split faced masonry, heavy timber canopies, wood trellis', etc. create the integrated aesthetics of Shoppes at Spanish Trail.

### **Screening**

All mechanical and/or electrical units; roof top or ground mounted must be screened from public view with the same material used on the building façade. Whenever possible the exterior building walls will be extended to accomplish this. Metal screen walls are not permitted. Pad-mounted equipment is required to be screened with masonry walls and /or plant material, where possible.

### **Trash Enclosures**

All trash enclosures shall match the Shoppes at Spanish Trail standard for finishes and City of Barstow Public Work Standards. Trash enclosures shall be a minimum of 6' high with split face masonry walls and pre-cast concrete caps. Gates shall be steel frames with metal decking infill and painted. See Exhibit 3.35 for the Trash Enclosure Details.

### **Orientation**

All buildings are subject to the setback requirements per City of Barstow local zoning ordinances and building codes.

Outparcel development is encouraged to place the building as close to the public street as possible in order to provide visibility and to provide a "Street Scene" on the public streets. All buildings must be within the "permissible building area" shown on Exhibit "X". Please note that the designated view corridors, and setback requirements may be affected by the public or private characterization of adjacent roadways or access roads.

### **Prohibited Exterior Elements**

Exterior exposed fire escapes, exposed service stairs or ladders, radio or television towers, and antennae or satellite receivers are not permitted. If required, installation and location shall be coordinated with Barstow Shores, LLC. All flat roof drainage is to be handled with an internal drainage system. No scuppers or leaders for flat roofs may be visible to the public.



STYLE OF ARCHITECTURE - INSPIRATION IMAGES

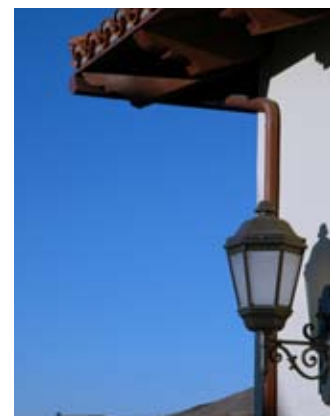



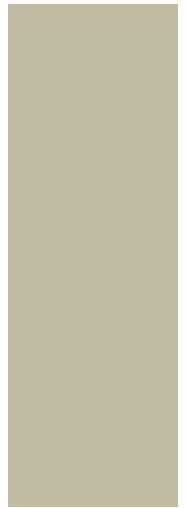



ARCHITECTURAL DETAILS - INSPIRATION IMAGES

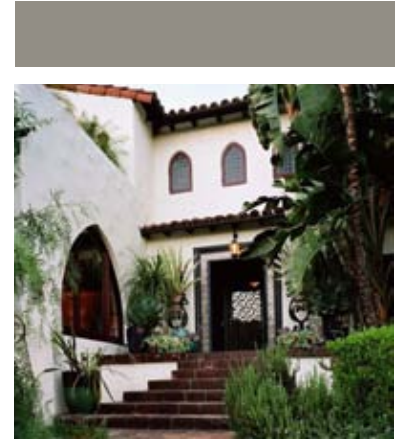









SPANISH  
REVIVAL  
ROOF

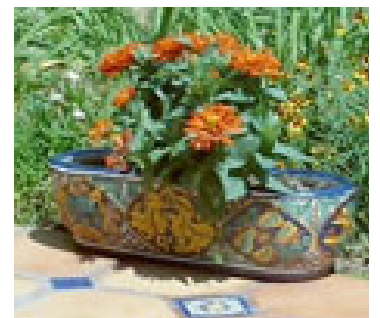
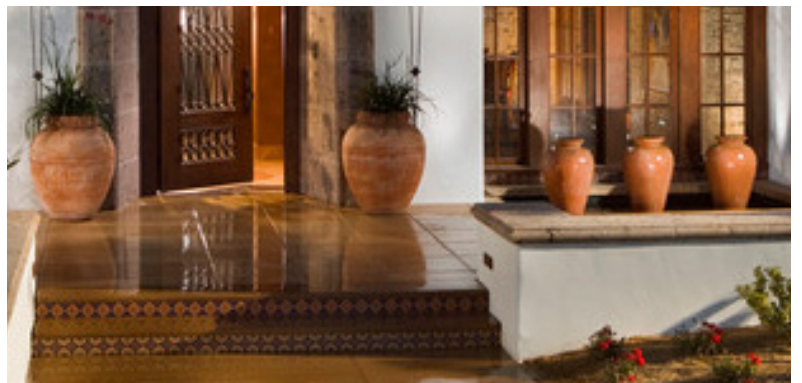

PLANTERS/PLANTS

SPANISH REVIVAL





# SPANISH REVIVAL

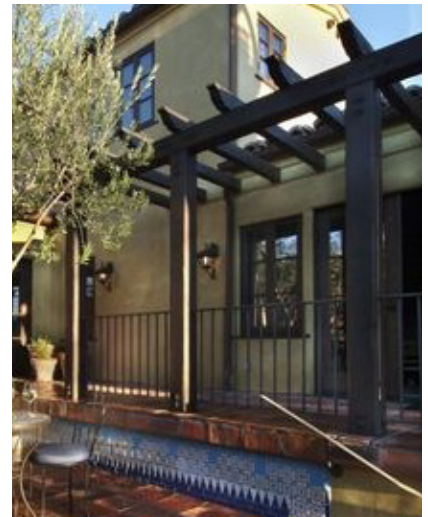

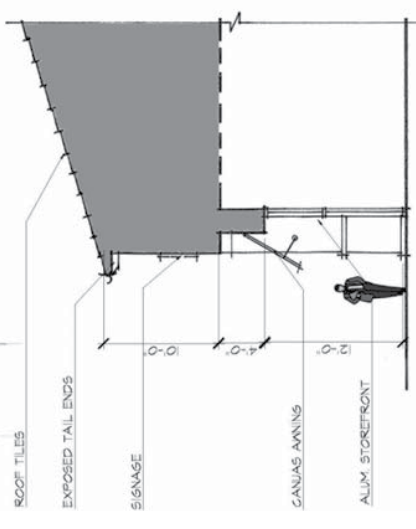
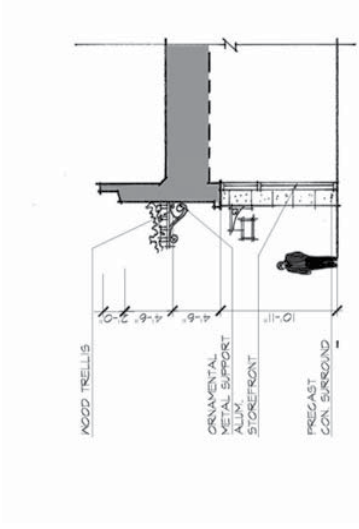
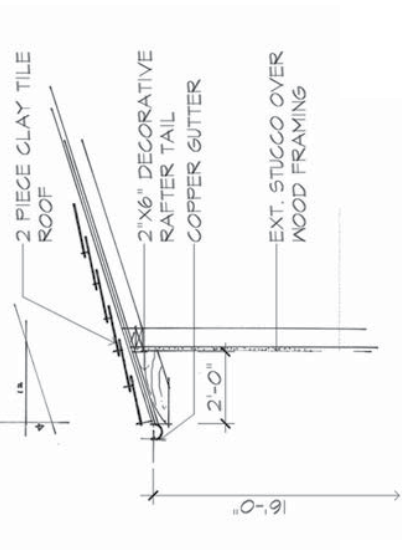
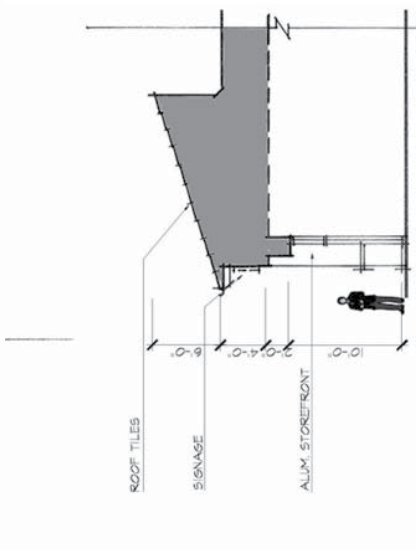
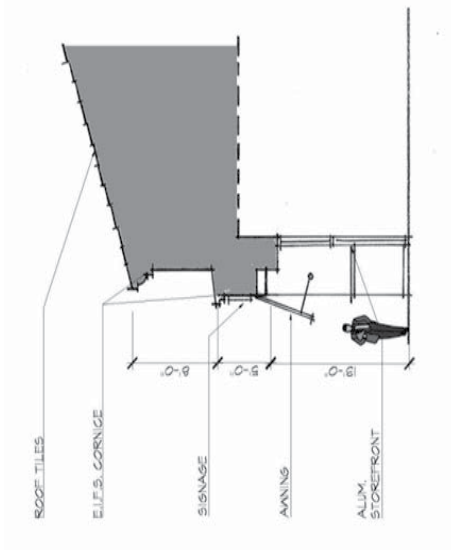
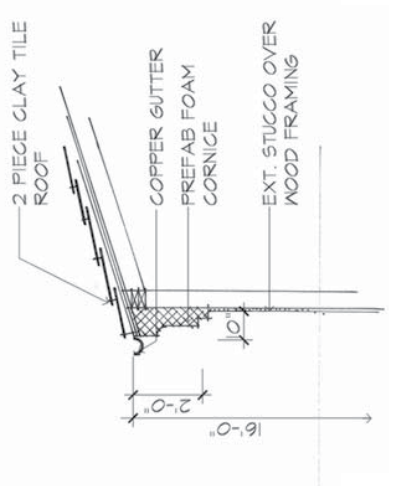
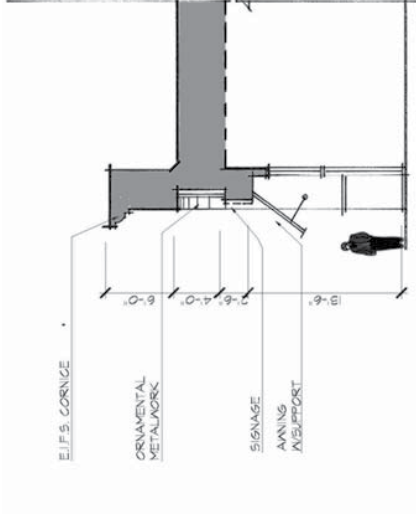
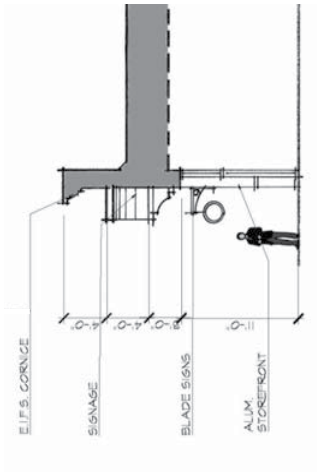

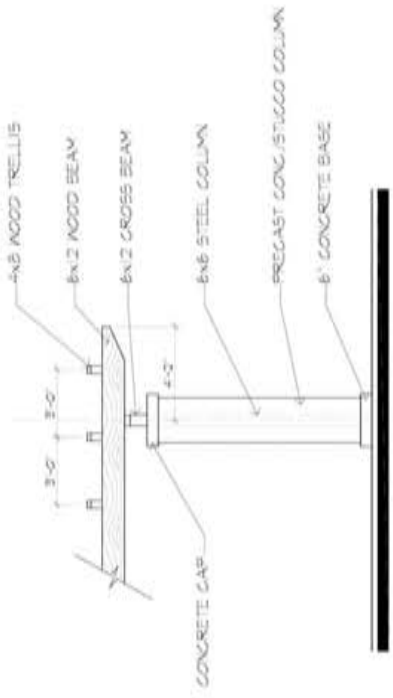

ELEVATION

TRELLIS

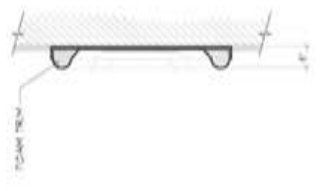

SECTION

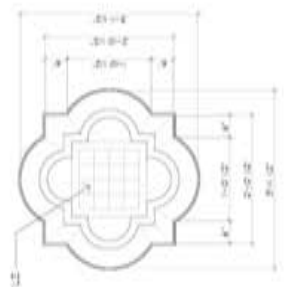

ELEVATION

ARCHITECTURAL  
ELEMENT

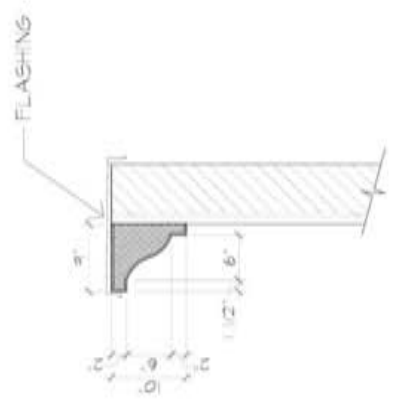

SECTION B

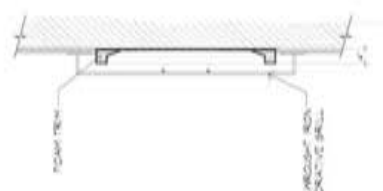

SECTION

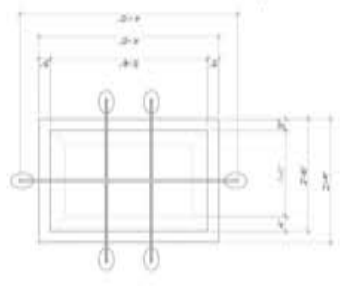

ELEVATION

ARCHITECTURAL  
ELEMENT

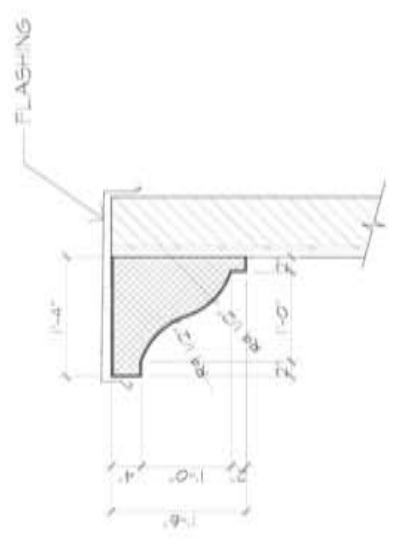

SECTION A

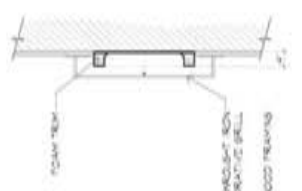

SECTION

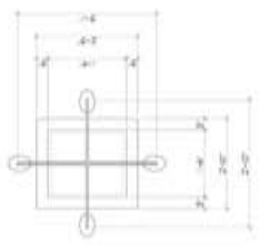

ELEVATION

ARCHITECTURAL  
ELEMENT



## **4.3 Sign Criteria**

### Introduction

The purpose of these criteria is to establish sign design standards and general guidelines that assure consistency in quality and necessary to balance maximum identification within an overall harmony of design for the project.

Conformance to these criteria will be strictly enforced. Any installed non-conforming or unapproved signs shall be brought into conformance at the expense of the Tenant and/or his Sign Contractor.

### Approval Procedure

All signs installed or displayed on the premises of Shoppes and Spanish Trail must have written approval of the Landlord/Developer. The aesthetic characteristics of the signs (i.e., placement, size, proportion, colors, textures, method of fabrication, location of transformers and electrical devices, etc.) are subject to the discretionary approval of the Landlord/Developer within the context of these criteria. Including but not limited to temporary promotional signs.

Prior to submission to the City of Barstow for permits, and prior to construction and installation of any sign or graphic covered by these criteria, tenant must submit three (3) sets of professionally prepared drawings of their proposed signage meeting these criteria to Landlord/Developer for review and approval.

### Drawings must:

1. Depict sign on building elevation with dimensional location and scale.
2. Include all specifications for construction and installation, including but not limited to, colors, materials, and illumination details. Following Landlord/Developer approval, Tenant must submit approved drawings to the City of Barstow for review and permits prior to construction. All design, processing and construction shall be at the Tenant's sole cost and expense.

### General Requirements

1. All work is to be performed by a professional sign company. Said sign company must be in possession of a current contractor's license to perform such work, in addition to a current city business license. Said sign company must maintain a minimum of \$1,000,000 insurance to be working on property.
2. All signs shall be reviewed and approved in writing by the Landlord/Developer for conformance with these criteria and overall design quality as well as Tenant's lease agreement. Approval or disapproval of sign submittal based on aesthetics of a design shall remain the sole right of the Landlord / Developer. Tenant shall submit (3) complete color copies to Landlord for review and approval.
3. After landlord / developer approval, each tenant shall submit or cause to be submitted to the City of Barstow for approval before fabrication three (3) copies of detailed drawings, to scale, indicating the location, size, layout, design and color of the proposed signs, including all lettering and or graphics. These drawings should be submitted along with site plan indicating the location of the lease space on the site, and elevation showing sign placement and lease space width. NOTE: All sign layouts shall include a digital image of the building frontage with proposed sign in a scaled format to include adjacent tenant signage, if applicable.
4. All signs must comply with current City of Barstow planning, zoning, building and electrical codes.
5. City Approval and Permits: Upon approval by the Landlord/Developer, Tenant shall secure a sign permit from the City of Barstow by bringing three (3) copies of the proposed drawings (approved by the Landlord/Developer) to the Planning Department. All permits required by the City of Barstow for signs and their installation must be obtained and paid for by the Tenant prior to installation.
6. All building signs shall be constructed and installed at Tenant's expense. Tenant is also responsible for the maintenance of building signs.

7. In the event a Tenant vacates his premises, Tenant shall be responsible for the removal of any wall and/or logo sign, with all holes being repaired and repainted to match the building exterior.
8. Tenant's sign contractor shall repair any damage to building exterior or common area caused by his actions. Incomplete repairs are the ultimate responsibility of the Tenant.
9. Upon notice by the City of Barstow or the Landlord/Developer, a Tenant shall be required to repair or refurbish their sign structure, sign face and/or sign illumination within seven (7) working days.
10. All electrical signage shall bear the Underwriter Laboratories (UL) label of approval. All conduit, transformers, junction boxes, openings in the building surface, etc. shall be concealed. The City of Barstow and the Landlord/Developer shall approve the method of installation.
11. Tenant is responsible for maintenance and cost of electricity for their own signage. The tenant shall be responsible to connect to the existing house panel J-box (electrical circuit from the house electrical panel for their signage). Tenant to provide sign connection wiring from J-box at sign location.
12. Tenant shall be fully responsible for the operations of his sign contractor and shall indemnify, defend and hold harmless the Landlord/Developer and his agents from damages or liabilities resulting from his contractor's work.
13. Registered trademarks, herein referred to as Registered Corporate Identity, pertains to corporate logos and logotypes that have been registered and are on file with the UNITED STATES PATENT AND TRADEMARK OFFICE in Washington, D.C.
14. Signs not covered by these criteria are subject to prior review and approval of the Landlord/Developer and shall conform to the requirements of the City of Barstow Sign Standards and the City of Barstow Code.
15. Sign Manufacturer identification. All signs must have the sign manufacturers name, address, and telephone number conspicuously and permanently attached on the exterior of the sign.
16. Leasing signs shall be restricted to the window of the available suite. These signs shall follow the same criteria as window graphics.

## Types of Signs

### Tenant Storefront Signage / Channel Letters

1. All Tenant storefront signage at the Shoppes at Spanish Trail should be designed to conform to specifications required in this criteria. Tenant signs may use a maximum of 30" or 60" in height, as noted on the specification pages. All tenant sign widths shall be determined by Tenant lease frontage calculated based on two (2) square foot of sign area for every lineal foot of leasehold frontage (2:1). Tenant copy shall be contained within the dimensions of the designated sign band area for each tenant not to exceed 75% of the tenant frontage. Distance from the edge of the sign to the end of the suite shall be a minimum of 5' in all cases.
2. Logos: See elevation pages for height restriction on logos.
3. Building frontage may not be combined to permit longer signs on any one building frontage. Signs shall be attached to the building parallel to the building face. No portion of any sign or its supporting structure may project more than five inches (5") from the face of the building or structure to which it is attached. No wall sign shall project above the roof line or below the bottom edge of the sign band. Bright fluorescent colors will only be accepted in cases of registered corporate trademarks.
4. Temporary Window Signs: Temporary window signs shall be tasteful and never appear cluttered. Painted

advertisements will not be allowed. All window signs must look professional and be maintained to look as new. The window is intended to be used as a means by which pedestrians look into the store not as an advertising canvas. Window signs may not exceed more than 144" square inches of the glazing area on which they will be applied. These graphics will not be calculated in the allowable sign area. High performance white or black 3M vinyl to be used.

5. Temporary Promotional Signs Banners, pennants, flags, non-metallic inflatable devices and balloons promoting grand openings, special sales, outdoor exhibitions and other temporary events shall conform to the zoning code. Temporary promotional signs must be kept in good condition at all time and never pose a hazard or inconvenience to adjacent tenant or consumer.

6. Permanent Window graphics: Tenants will be allowed one (1) identification and information sign on their front window adjacent to the main entry door. Graphics will be limited to white high performance self-adhesive vinyl. The maximum area for the sign is 24" x 24" square. Lettering shall not exceed 4" in height and logos shall not exceed 10" in height. Supportive text shall be limited to 1" tall lettering set in legend form. Graphics and store hours shall be centered vertically at 60" and must be centered on door.

7. Blade signs: Tenants under 14,000 square feet will be allowed one (1) identification blade sign mounted on the front elevation.

### General Specifications

1. Signs shall be manufactured to U.L. Specifications and display appropriate U.L. labels.

2. Signs to be limited to Tenant's Trade Name as approved in the tenant lease.

3. Signs shall be individually fabricated letters of channel letter construction with 3/16" acrylic faces.

4. Letter frames (returns) shall be 5 inches, fabricated from aluminum with acrylic polyurethane finish to match face.

5. 3/4" trim cap edge shall also match face of letter.

6. Letters may be any bold sans serif or serif type style. Decorative or delicate serifs and strokes, italic or script letterforms are not permitted unless embedded as part of the tenant's logo or insignia.

7. All internally illuminated signs shall use 15mm double line neon tubes or LED lighting system.

8. Individual sign letters shall be mounted flush with the building fascia without use of exposed raceways.

9. All attachment devices, wiring, transformers, tubes and other mechanisms required for the sign shall be concealed.

10. Signage graphics and letterforms shall not project above the parapet, fascia, wall or roofline to which it is attached. A minimum of 1/8 of the overall sign height shall be maintained as a clear space around each edge of the sign and may not cross over the parapet if any significant architectural feature.

11. The tenant is encouraged to display name in a single line of text. However, up to three lines of text may be used as long as the overall height does not exceed the letter height allowed on the elevation it is placed.

12. Where more than one sign is permitted to a business, all signs shall be consistent in design, style, shape, color, illumination and text.

13. Tenants that occupy an entire building may be allowed to increased sign height, as long as the overall signage area does not exceed two (2) square feet per linear foot of building frontage on the elevation it is placed, as determined by the lease line.

14. Logos and other corporate insignias are permitted, as long as the overall height does not exceed the height allowed on the elevation it is placed. The vertical height of the lettering may not exceed the height of the logo.

15. Color of graphics will be subject to the approval of the Landlord. Trim cap edges and letter returns to match the face color. Background is to be existing building color. Painted signs shall not be permitted.
16. All signs using lags, fasteners, or screws are to be rust proof plated or stainless steel and installed in a concealed manner. All tenant signage must also have full weld construction; all building penetrations are to be watertight sealed. Tenants shall not have labeling or other identifications exposed.
17. Tenant's electrical service is from tenant power source on automatic time clock to hours of business. Typically all tenant signage shall not have any exposed illumination or flood lighting.
18. Sheet metal will not be permitted on any tenant signage.
19. Contractors shall repair any and all damages caused by their work.

## Sign Restrictions

### PROHIBITED SIGNS

1. Signs constituting a Traffic Hazard: No person shall install or maintain, or cause to be installed or maintained, any building sign which simulates or imitates in size, color, lettering or design any traffic sign or signal, or which makes use of the words "STOP", "LOOK", "DANGER" or any words, phrases, symbols, or characters in such a manner as to interfere with, mislead or confuse traffic.
2. Signs in Proximity to Utility Lines: Signs which have less horizontal or vertical clearance from authorized communication or energized electrical power lines that are prescribed by the laws of the State of California are prohibited.
3. Signs painted directly on a wall will not be permitted.
4. Wall signs may not project above the top of a parapet, the roof line at the wall, or roof line. Signs on mansard roofs and equipment screens are prohibited.
5. There shall be no signs that are rotating, revolving, flashing, moving or audible.
6. No sign shall project above or below the sign-able area. The sign-able area is defined in the attached Exhibit for minor and major tenants.
7. Advertising or promotional signs on parked vehicles are prohibited. This includes signs on or affixed to trucks, automobiles, trailers or other vehicles which advertise, identify or provide direction to a use or activity within the shopping center, and which are not related to the vehicle's lawful activity. This provision does not apply to service and delivery vehicles of Occupants when engaged in regular business activities (e.g. Trucks making deliveries to businesses within the center).
8. Billboard Signs are prohibited except for landlord leasing signs and identification signs.
9. The use of a permanent sale sign is prohibited. The temporary use of these signs are limited to a thirty-day period and is restricted to signs affixed to the interior of windows which do not occupy more than 10% of the window area. Each business is permitted a total of not more than ninety (90) days of temporary window sale signs per calendar year. Subject to landlord / developer approval.
10. Any sign not indicated in this sign program shall be considered prohibited unless approved Landlord and City of Barstow sign regulations.
11. Signs must be architecturally compatible with the entire center.
12. All materials used in signage construction and installation must be new. No used materials will be allowed.
13. Temporary signs, including flags, banners or pennants, or a combination of same, may be permitted (e.g. for an-

nouncing openings and re-openings after remodels) subject to Municipal Code requirements, Landlord / Developer and City approval. Size, location and duration of temporary signage shall be as specified in the Municipal Code requirements of Barstow and approved by Landlord.

#### Other Restrictions

##### Illegal Signs

Any sign that is deemed not to be in conformance with the approved Sign Plan or erected without government approval or permits is considered an illegal sign. The Landlord / Developer may, as its sole discretion and at Occupant's expense, correct, replace or remove any illegal sign.

##### Abandonment of Signs

A sign is considered abandoned when it's use is discontinued because the premises upon which it is located becomes vacated and unoccupied for a period of more than 90 days. The Landlord / Developer may, at its sole discretion and at Occupant's expense, replace or remove any abandoned sign.

##### Inspection

The Landlord / developer reserves the right to hire an independent electrical engineer at the Occupant's sole expense to inspect the installation of all Occupant's signs and to require the Occupant to have any discrepancies and/or code violations corrected at the Occupant's expense.





# Typical Monument Sign

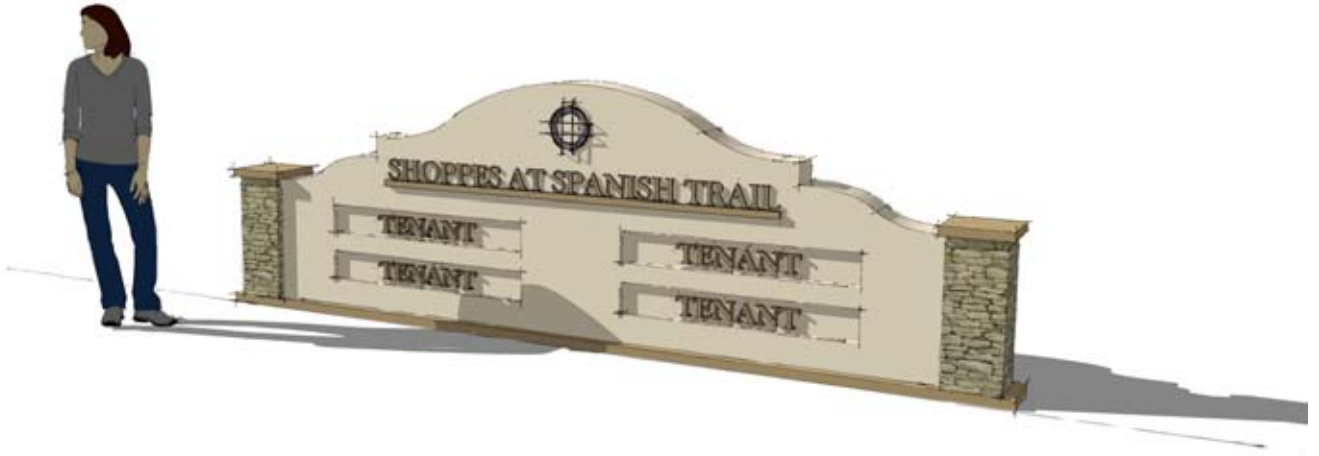

## 4.4 Landscape Guidelines

### Introduction

Proper landscaping techniques not only create beautiful landscapes, but also benefit the environment and save water. In addition, attractive, water efficient, low maintenance landscapes can increase property value. Of the seven principles upon which sustainable water efficient landscaping is based, proper planning and design is perhaps the most critical. A plant palette and landscape plan has been developed that takes into account the regional and microclimatic conditions of the site, topography, intended use of the property, and most importantly, the grouping of plants according to their water needs. The plant palette attempts to maximize the use of native and drought tolerant plant material without compromising the aesthetic beauty of the project. Turf areas will be limited to those needed for practical uses and water efficient irrigation system will be implemented to minimize water use and runoff concerns. The landscape concept developed involved extensive research and incorporated the works of:

1. Climate Action Network Best Practices Framework prepared by the Institute for Local Government
2. City of Barstow General Plan
3. City of Barstow Landscape Identity and Design Standards 2012
4. County of San Bernardino 2007 Development Code
5. California Model Water Efficient Landscape Ordinance
6. Sneezeless Landscaping prepared by The American Lung Association of California

This well thought out landscape plan will serve as our roadmap in creating a beautiful, water efficient landscape at the Shoppes at Spanish Trail.

The landscape design guidelines for the Purchasor/Lessor coordination package achieves three major goals.

1. Insures the high level of quality matches those established by the Shoppes at Spanish Trail, and the landscape architect for the overall site development.
2. Insures a consistent and aesthetically cohesive development.
3. Insures that plant material selection and size reflects the development and city standards.

These guidelines are flexible and illustrative. Variations must adhere to the design intent identified and must be approved by Shoppes at Spanish Trail and the City of Barstow Planning Department.

Specific goals identified in the specific plan are important to reinforce:

1. Provide a distinctive landscape setting both complementing and contrasting with surrounding land uses.
2. Create a sense of arrival through use of entry monuments/gateways, street scenes/urban boulevards and medians.
3. Define and facilitate both pedestrian and vehicular circulation.
4. Allow for good visibility of businesses and retailers.
5. Development of an environment visually attractive and efficiently organized.
6. Buffer, through natural and man-made feature retail/ hospitality uses from nearby mixed density residential uses.
7. Encourage and allow for pedestrians, promenades and people places.
8. Provide for thematic continuity through consistent use of contemporary materials, forms, signs and other graphic elements.
9. Present a strong identity comparable with the Barstow environment: climate, soils and horticulture.
10. Implement design practices from "American Lung Association's "Sneezeless Landscaping", and A Landscape of Choice – Strategies for Improving Patterns of Community Growth" where feasible.
11. Utilize drip/point source irrigation systems with 'smart' controllers.
12. Utilize low OFP (Ozone Forming Potential) trees where feasible.
13. Utilize interceptor trees where feasible.
14. Utilize trees that were prevalent during the 1829-1848 period, such as Fremont Cottonwood and Desert Oak, along the interpretive pedestrian pathway and at key gathering locations within the site.

The landscape guidelines are divided into the following sections.

- A. Project Entries
- B. Parking lot
- C. Screening

#### Plant Material Standards

- 1. Plant Species
- 2. Plant Installation time
- 3. Soil testing
- 4. Maintenance Standards
- 5. Guarantees and Warranties
- 6. Irrigation Standards
- 7. Construction Document approvals.

#### Project Entries

Special landscaping, specimen trees, berming, and lighting shall be placed at the project entries to identify and establish the character of the Marketplace at El Paseo. Shrubs and ground covers with annual or perennial color should be used to highlight key areas, such as the base of monument signs. Enriched paving treatments such as interlocking pavers or colored concrete should be used to denote project entries.

#### Parking Lot

Parking lot requirement shall follow the City of Barstow Design Guidelines and the plant palette established in this design guideline. Fifty percent of the parking stall area shall be shaded when trees reach maturity. Trees, shrubs, groundcover shall be per the landscape plans approved by the City of Barstow. See Exhibit 3.11 for the Conceptual Landscape Plan.

#### Screening

Service areas and trash enclosures.

Both areas must be screened from streets, pedestrian walks, parking lots and adjacent buildings. Screening is to be accomplished by a solid perimeter wall or landscaping.

#### Plant Material Standards

##### 1. Planting Species

It is the intent of these guidelines to provide flexibility in plant material selection. It is important to establish a simplified, limited palette in order to reinforce the project landscape concept and create unity through out the project. The plant material identified in the specific plan is pre-approved by the City of Barstow and determined to be appropriate to climatic conditions, soil conditions and maintenance standards. Those plant Materials identified in specific areas such as parking lots and buffer areas must follow these guidelines with no alternatives accepted. Specific plant material and sizes are identified in each exhibit.

##### 2. Planting Time.

Due to the climate extremes of the Barstow area the installation of plant materials during the coldest winter months (December through March) and the hottest summer/fall months (July through September) can be difficult. Container plant materials not acclimated to the area can easily suffer from damage or sun/heat exposure resulting in partial or entire foliage loss even though such materials are perfectly suited to the temperature ranges once established. If planting must be done during these difficult months, plant establishment may be difficult and require a prolonged period of time to guarantee plant's success.

##### 3. Maintenance standards

- 1. Cultivation and weeding of all planting areas.
- 2. Applying herbicides for weed control in accordance with manufacturers instructions.
- 3. Remedy damage from use of insecticides.
- 4. Irrigating sufficient to saturate root system. Test soil moisture level on weekly basis.
- 5. Pruning, including removal of dead or broken branches and treatment of pruned areas

or other woods. Shape plants directed by Landscape architect.

- 6. Disease control.
- 7. Maintaining wrappings, guys, turn buckles and stakes. Adjust turnbuckles to keep guy

wires tight. Repair or replace accessories when required.

8. Replacement of mulch.
9. Fertilizer per soil test results.
10. Sod maintenance:
  - a. Mow grass at regular intervals to maintain a maximum height to 2-1/2 inches. Do not cut more than 1/3 of grass blade at any one mowing.
  - b. Neatly trim edges and hand clip where necessary.
  - c. Immediately remove clippings after mowing and trimming.
  - d. Water to prevent grass and soil from drying out.
  - e. Roll surface to remove minor depressions or irregularities.
  - f. Control growth of weeds. Apply herbicide in accordance with manufacturer's instructions. Remedy damage resulting from improper use of herbicides.
  - g. Immediately replace sod to areas which show deterioration or bare spots.
  - h. Protect sodded areas with warning signs during maintenance period.
11. Removal of site trash.

#### 4. Guarantees and Warranties

The warranty and guarantee period shall begin after written acceptance of the project.

- a. Provide a one year warranty for all plant materials.
- b. Replacements: plants of the same size and species planted in the next growing season, with a new warranty commencing on date of replacement. Any plant material that is not healthy, dies, is dying or the design value of which in the opinion of the Landscape Architect has been so injured or damaged as to render it unsuitable for the purpose intended, shall be replaced immediately.
- c. Provide Owner with written warranties and guarantees for all products. Soil compactions shall be guaranteed for 1.5 years against improper compaction, excessive settling, and rapid decomposition of soil.
- d. Provide manufacturers warranty for all products.

#### Irrigation Standards

1. All Landscape Zones are to be watered with an automatic irrigation system.
2. Drip/point source irrigation systems are to be installed in all shrub areas where feasible.
3. The irrigation system is to be monitored by a 'smart' automatic irrigation controller (smart controllers are linked to satellites which feed climate relevant information to the controller to prevent over/under watering).
4. The location of all irrigation equipment, including valves, controllers, sprinkler heads, drip equipment, mainline and lateral line piping shall be indicated on the irrigation drawings. While the irrigation plans are diagrammatic, it is important that the sprinkler head placement be accurately indicated on the drawings.
5. Valve circuits shall be separated by hydrazones, plant materials with different water requirements shall be irrigated separately, i.e. turf and shrub areas shall be irrigated separately.
6. Irrigation spray shall not go beyond landscaped zones. All heads shall be adjustable.
7. Outlot parcel irrigation is to be watered from their own water source.
8. All valves are to be located within groundcover or shrub beds. Controllers, backflow preventors and other equipment are to be easily accessible, yet not visible to the general public.
9. Developers are to be consistent with the City of Barstow's and the State of California's Water Efficient Landscape Standards (and general water conservation measures).

#### Construction Documents

Submit conceptual landscape and irrigation, and construction documents to Shoppes at Spanish Trail and the City of Barstow for review of conformance to this document and City of Barstow Requirements.



ARCHITECTURAL DETAILS - TILES / AWNINGS / PAVING

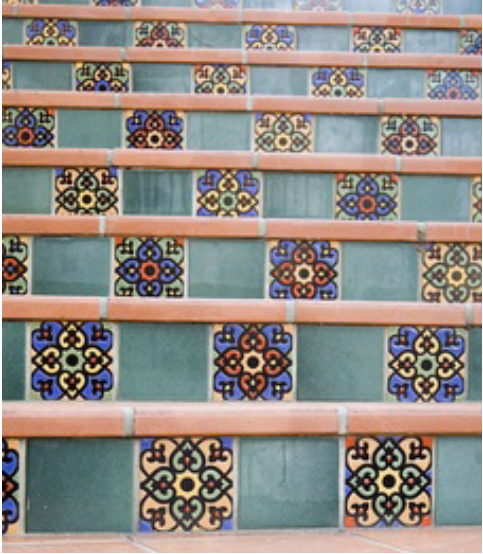

TILES



AWNINGS

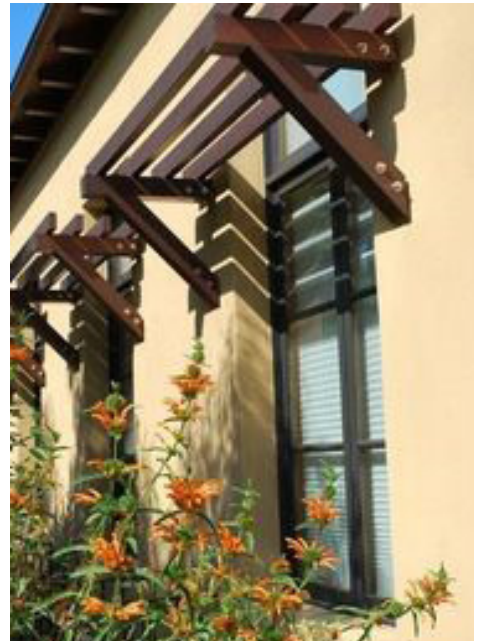



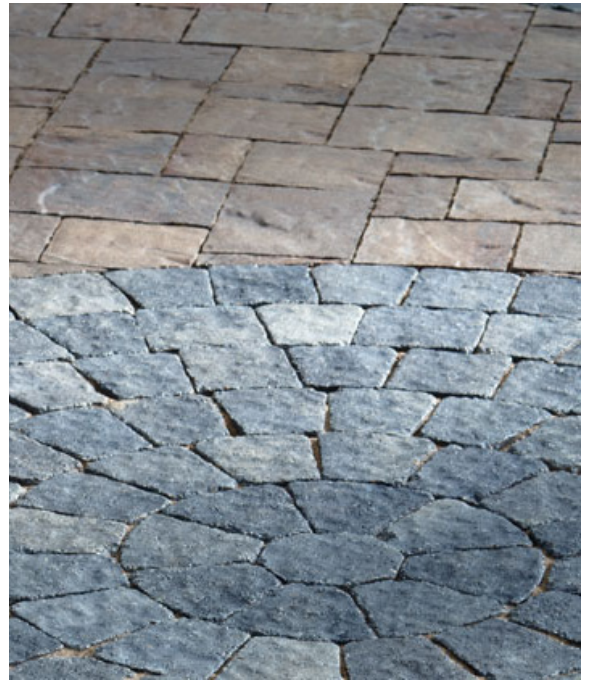
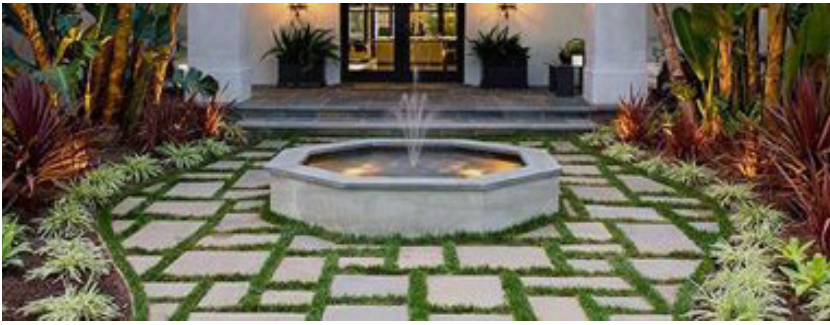

# SPANISH REVIVAL





ARCHITECTURAL DETAILS - DECORATIVE ACCENTS

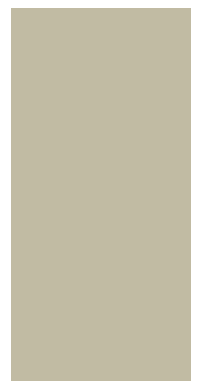

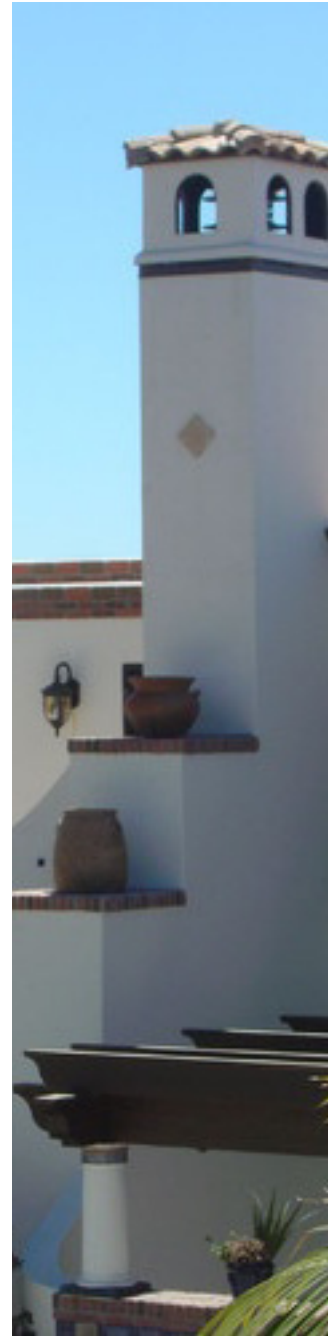

# SPANISH REVIVAL

